

Celite

# M E \_ T A I S



**FLOW**

| IMAGEM  | CÓDIGO     | DESCRIÇÃO   |
|---|------------|---|
|    | B5000F3CRB | <p>MISTURADOR PARA LAVATORIO DE MESA 3 FUROS BICA ALTA COM VALVULA DE ESCOAMENTO FLOW</p> <p>CROMADO<br/>Caixa master: 2</p>                                    |
|    | B5001F3CRB | <p>MISTURADOR PARA LAVATORIO DE PAREDE COM VALVULA DE ESCOAMENTO FLOW</p> <p>CROMADO<br/>Caixa master: 2</p>  |
|   | B5002F3CRB | <p>TORNEIRA PARA LAVATORIO DE MESA BICA ALTA FLOW</p> <p>CROMADO<br/>Caixa master: 2</p>  |
|  | B5003F3CRB | <p>TORNEIRA PARA LAVATORIO DE PAREDE FLOW</p> <p>CROMADO<br/>Caixa master: 2</p>  |
|  | B5004F3CRB | <p>DUCHA HIGIENICA COM DERIVAÇÃO FLOW</p> <p>CROMADO<br/>Caixa master: 2</p>  |
|  | B5008F3CR0 | <p>ACABAMENTO DE REGISTRO BASE CELITE 1.1/4, 1.1/2 FLOW (COMPATÍVEL COM A BASE DE REGISTRO DOCOL E CELITE DE 20 ESTRIAS)</p> <p>CROMADO<br/>Caixa master: 2</p> |

|   |                   |  |
|---|-------------------|--|
|   | <p>B5005F3CR0</p> | <p>ACABAMENTO DE REGISTRO BASE CELITE 1/2, 3/4, 1 FLOW (COMPATÍVEL COM A BASE DE REGISTRO DOCOL E CELITE DE 20 ESTRIAS)</p> <p>CROMADO<br/>Caixa master: 2</p>     |
|  | <p>B5009F3CR0</p> | <p>ACABAMENTO DE REGISTRO BASE REFORMA 1.1/4, 1.1/2 FLOW (COMPATÍVEL COM A BASE DE REGISTRO DECA E SIMILARES DE 16 ESTRIAS)</p> <p>CROMADO<br/>Caixa master: 2</p> |
|  | <p>B5006F3CR0</p> | <p>ACABAMENTO DE REGISTRO BASE REFORMA 1/2, 3/4, 1 FLOW (COMPATÍVEL COM A BASE DE REGISTRO DECA E SIMILARES DE 16 ESTRIAS)</p> <p>CROMADO<br/>Caixa master: 2</p>  |



**BASIC PLUS**

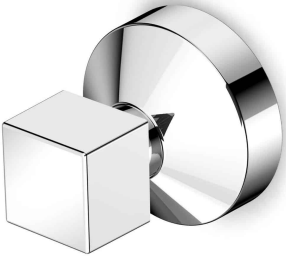
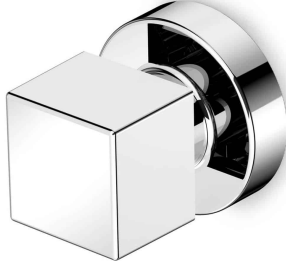

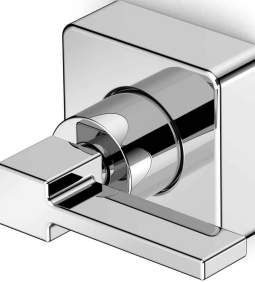
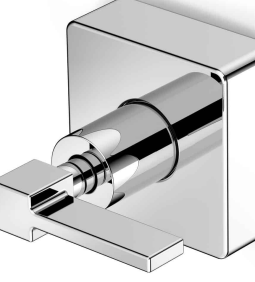
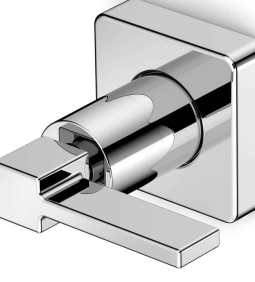

| IMAGEM  | CÓDIGO     | DESCRIÇÃO   |
|---|------------|---|
|    |            | TORNEIRA PARA LAVATORIO DE MESA BICA ALTA BASIC PLUS  |
|   | B5001CBCRB | CROMADO<br>Caixa master: 2  |
|    |            | TORNEIRA PARA LAVATORIO DE MESA BICA BAIXA BASIC PLUS   |
|   | B5000CBCRB | CROMADO<br>Caixa master: 2  |
|  |            | TORNEIRA PARA LAVATORIO DE PAREDE BASIC PLUS  |
|   | B5002CBCRB | CROMADO<br>Caixa master: 2  |
|  |            | DUCHA HIGIÊNICA COM DERIVAÇÃO BASIC PLUS  |
|   | B5003CBCRB | CROMADO   |
|  |            | ACABAMENTO DE REGISTRO BASE CELITE 1.1/4, 1.1/2 BASIC PLUS (COMPATÍVEL COM A BASE DE REGISTRO DOCOL E CELITE DE 20 ESTRIAS) |
|   | B5007CBCRB | CROMADO<br>Caixa master: 2  |
|  |            | ACABAMENTO DE REGISTRO BASE CELITE 1/2, 3/4, 1 BASIC PLUS (COMPATÍVEL COM A BASE DE REGISTRO DOCOL E CELITE DE 20 ESTRIAS)  |
|   | B5005CBCRB | CROMADO<br>Caixa master: 2  |

|   |                   |   |
|---|-------------------|---|
|   | <p>B5006CBCRB</p> | <p>ACABAMENTO DE REGISTRO BASE REFORMA<br/>1.1/4, 1.1/2 BASIC PLUS (COMPATÍVEL COM A<br/>BASE DE REGISTRO DECA E SIMILARES DE 16<br/>ESTRIAS)</p> <p>CROMADO</p>                    |
|  | <p>B5004CBCRB</p> | <p>ACABAMENTO DE REGISTRO BASE REFORMA<br/>1/2, 3/4, 1 BASIC PLUS (COMPATÍVEL COM A<br/>BASE DE REGISTRO DECA E SIMILARES DE 16<br/>ESTRIAS)</p> <p>CROMADO<br/>Caixa master: 2</p> |

ELITE

| IMAGEM  | CÓDIGO     | DESCRIÇÃO   |
|---|------------|---|
|    | B5000C8CRB | MISTURADOR PARA LAVATORIO DE MESA 3 FUROS BICA ALTA COM VALVULA DE ESCOAMENTO ELITE<br><br>CROMADO<br>Caixa master: 2 |
|    | B5001C8CRB | MISTURADOR PARA LAVATORIO DE PAREDE COM VALVULA DE ESCOAMENTO ELITE<br><br>CROMADO<br>Caixa master: 2                 |
|   | B5002C8CRB | TORNEIRA PARA LAVATORIO DE MESA BICA ALTA ELITE<br><br>CROMADO<br>Caixa master: 2                                     |
|  | B5003C8CRB | TORNEIRA PARA LAVATORIO DE PAREDE ELITE<br><br>CROMADO<br>Caixa master: 2   |
|  | B5007C8CRB | DUCHA HIGIÊNICA COM DERIVAÇÃO ELITE<br><br>CROMADO<br>Caixa master: 2   |
|  | B5004C8CRB | MISTURADOR PARA BIDÊ DE 3 FUROS COM DUCHA ELITE<br><br>CROMADO  |

|   |                   |   |
|---|-------------------|---|
|     | <p>B5010C8CR0</p> | <p>ACABAMENTO DE REGISTRO BASE CELITE 1.1/4, 1.1/2 ELITE (COMPATÍVEL COM A BASE DE REGISTRO DOCOL E CELITE DE 20 ESTRIAS)</p> <p>CROMADO<br/>Caixa master: 2</p>    |
|    | <p>B5005C8CRB</p> | <p>ACABAMENTO DE REGISTRO BASE CELITE 1/2, 3/4, 1 ELITE (COMPATÍVEL COM A BASE DE REGISTRO DOCOL E CELITE DE 20 ESTRIAS)</p> <p>CROMADO<br/>Caixa master: 2</p>     |
|    | <p>B5009C8CR0</p> | <p>ACABAMENTO DE REGISTRO BASE REFORMA 1.1/4, 1.1/2 ELITE (COMPATÍVEL COM A BASE DE REGISTRO DECA E SIMILARES DE 16 ESTRIAS)</p> <p>CROMADO<br/>Caixa master: 2</p> |
|   | <p>B5006C8CRB</p> | <p>ACABAMENTO DE REGISTRO BASE REFORMA 1/2, 3/4, 1 ELITE (COMPATÍVEL COM A BASE DE REGISTRO DECA E SIMILARES DE 16 ESTRIAS)</p> <p>CROMADO<br/>Caixa master: 2</p>  |
|  | <p>B8001C8CR0</p> | <p>CABIDE DUPLO ELITE</p> <p>CROMADO<br/>Caixa master: 4</p>  |
|  | <p>B8000C8CR0</p> | <p>CABIDE ELITE</p> <p>CROMADO<br/>Caixa master: 4</p>  |

|   |                   |  |
|---|-------------------|--|
|     | <p>B8003C8CR0</p> | <p>PAPELEIRA ELITE</p> <p>CROMADO<br/>Caixa master: 2</p>  |
|    | <p>B8004C8CR0</p> | <p>TOALHEIRO ANEL ELITE</p> <p>CROMADO<br/>Caixa master: 2</p>                                   |
|    | <p>B8005C8CR0</p> | <p>TOALHEIRO BARRA 600 MM ELITE</p> <p>CROMADO<br/>Caixa master: 2</p>                           |
|  | <p>B8002C8CR0</p> | <p>SABONETEIRA ELITE</p> <p>CROMADO<br/>Caixa master: 2</p>                                      |
|  | <p>B5008C8CRB</p> | <p>CHUVEIRO COM BRAÇO DE PAREDE<br/>QUADRADO 220 MM ELITE</p> <p>CROMADO<br/>Caixa master: 2</p> |





LOTUS

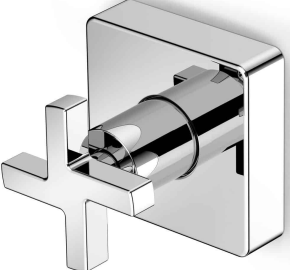
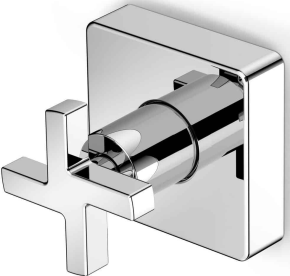
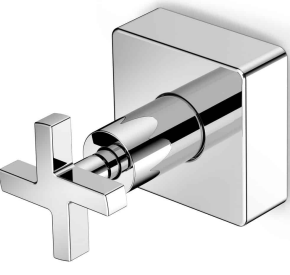
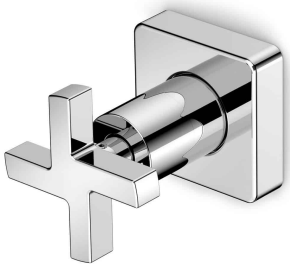



| IMAGEM  | CÓDIGO     | DESCRIÇÃO   |
|---|------------|---|
|    | B5000CACRB | MISTURADOR PARA LAVATORIO DE MESA 3 FUROS BICA ALTA COM VALVULA DE ESCOAMENTO LOTUS<br><br>CROMADO<br>Caixa master: 2 |
|    | B5001CACRB | MISTURADOR PARA LAVATORIO DE PAREDE COM VALVULA DE ESCOAMENTO LOTUS<br><br>CROMADO<br>Caixa master: 2                 |
|   | B5002CACRB | TORNEIRA PARA LAVATORIO DE MESA BICA ALTA LOTUS<br><br>CROMADO<br>Caixa master: 2                                     |
|  | B5003CACRB | TORNEIRA PARA LAVATORIO DE PAREDE LOTUS<br><br>CROMADO<br>Caixa master: 2   |
|  | B5007CACRB | DUCHA HIGIÊNICA COM DERIVAÇÃO LOTUS<br><br>CROMADO<br>Caixa master: 2   |
|  | B5004CACRB | MISTURADOR PARA BIDÊ DE 3 FUROS COM DUCHA LOTUS<br><br>CROMADO  |



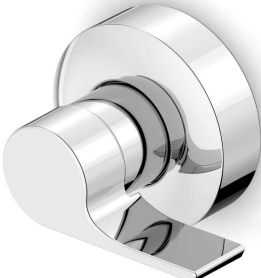

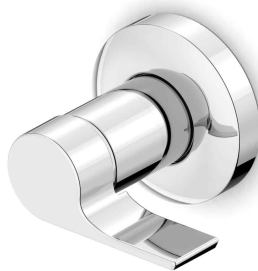

|  |                   |   |
|--|-------------------|---|
|    | <p>B5009CACR0</p> | <p>ACABAMENTO DE REGISTRO BASE CELITE 1.1/4, 1.1/2 LOTUS (COMPATÍVEL COM A BASE DE REGISTRO DOCOL E CELITE DE 20 ESTRIAS)</p> <p>CROMADO<br/>Caixa master: 2</p>    |
|   | <p>B5005CACRB</p> | <p>ACABAMENTO DE REGISTRO BASE CELITE 1/2, 3/4, 1 LOTUS (COMPATÍVEL COM A BASE DE REGISTRO DOCOL E CELITE DE 20 ESTRIAS)</p> <p>CROMADO<br/>Caixa master: 2</p>     |
|   | <p>B5008CACR0</p> | <p>ACABAMENTO DE REGISTRO BASE REFORMA 1.1/4, 1.1/2 LOTUS (COMPATÍVEL COM A BASE DE REGISTRO DECA E SIMILARES DE 16 ESTRIAS)</p> <p>CROMADO<br/>Caixa master: 2</p> |
|  | <p>B5006CACRB</p> | <p>ACABAMENTO DE REGISTRO BASE REFORMA 1/2, 3/4, 1 LOTUS (COMPATÍVEL COM A BASE DE REGISTRO DECA E SIMILARES DE 16 ESTRIAS)</p> <p>CROMADO<br/>Caixa master: 2</p>  |





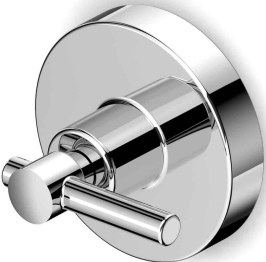

**MASTER**

| IMAGEM  | CÓDIGO     | DESCRIÇÃO   |
|---|------------|---|
|    | B5000CZCRB | <p>MISTURADOR PARA LAVATORIO DE MESA 3 FUROS BICA ALTA 90° COM VALVULA DE ESCOAMENTO MASTER</p> <p>CROMADO</p>                                |
|    | B5001CZCRB | <p>TORNEIRA PARA LAVATORIO DE MESA BICA ALTA 90° MASTER</p> <p>CROMADO</p>  |
|   | B5002CZCRB | <p>TORNEIRA PARA LAVATORIO DE PAREDE MASTER</p> <p>CROMADO</p>  |
|  | B5003CZCRB | <p>DUCHA HIGIÊNICA COM DERIVAÇÃO MASTER</p> <p>CROMADO</p>  |
|  | B5006CZCR0 | <p>ACABAMENTO DE REGISTRO BASE CELITE 1.1/4, 1.1/2 MASTER (COMPATÍVEL COM A BASE DE REGISTRO DOCOL E CELITE DE 20 ESTRIAS)</p> <p>CROMADO</p> |
|  | B5004CZCRB | <p>ACABAMENTO DE REGISTRO BASE CELITE 1/2, 3/4, 1 MASTER (COMPATÍVEL COM A BASE DE REGISTRO DOCOL E CELITE DE 20 ESTRIAS)</p> <p>CROMADO</p>  |

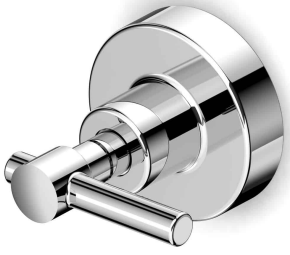
|   |                   |  |
|---|-------------------|--|
|     | <p>B5007CZCR0</p> | <p>ACABAMENTO DE REGISTRO BASE REFORMA 1.1/4, 1.1/2 MASTER (COMPATÍVEL COM A BASE DE REGISTRO DECA E SIMILARES DE 16 ESTRIAS)</p> <p>CROMADO</p> |
|    | <p>B5005CZCRB</p> | <p>ACABAMENTO DE REGISTRO BASE REFORMA 1/2, 3/4, 1 MASTER (COMPATÍVEL COM A BASE DE REGISTRO DECA E SIMILARES DE 16 ESTRIAS)</p> <p>CROMADO</p>  |
|    | <p>B5008CZCRB</p> | <p>MISTURADOR PARA COZINHA DE MESA BICA MÓVEL 90° COM AREJADOR ARTICULADO MASTER</p> <p>CROMADO</p>  |
|  | <p>B5009CZCRB</p> | <p>MISTURADOR PARA COZINHA DE PAREDE BICA MÓVEL 90° COM AREJADOR ARTICULADO MASTER</p> <p>CROMADO</p>  |
|  | <p>B5010CZCRB</p> | <p>TORNEIRA PARA COZINHA DE MESA BICA ALTA MÓVEL 90° COM AREJADOR ARTICULADO MASTER</p> <p>CROMADO</p>   |
|  | <p>B5011CZCRB</p> | <p>TORNEIRA PARA COZINHA DE PAREDE BICA MÓVEL 90° COM AREJADOR ARTICULADO MASTER</p> <p>CROMADO</p>  |

**LIFE PLUS**

| IMAGEM  | CÓDIGO     | DESCRIÇÃO  |
|---|------------|--|
|    | B5000C0CRB | <p>MISTURADOR PARA LAVATORIO DE MESA 3 FUROS BICA ALTA COM VALVULA DE ESCOAMENTO LIFE PLUS</p> <p>CROMADO<br/>Caixa master: 2</p>                                    |
|    | B5001C0CRB | <p>MISTURADOR PARA LAVATÓRIO DE PAREDE COM VÁLVULA DE ESCOAMENTO LIFE PLUS CROMADO</p> <p>CROMADO<br/>Caixa master: 2</p>  |
|   | B5003C0CRB | <p>TORNEIRA PARA LAVATORIO DE MESA BICA ALTA LIFE PLUS</p> <p>CROMADO<br/>Caixa master: 2</p>  |
|  | B5002C0CRB | <p>TORNEIRA PARA LAVATORIO DE PAREDE LIFE PLUS</p> <p>CROMADO<br/>Caixa master: 2</p>  |
|  | B5004C0CRB | <p>DUCHA HIGIÊNICA COM DERIVAÇÃO LIFE PLUS</p> <p>CROMADO<br/>Caixa master: 2</p>  |
|  | B5008C0CRB | <p>ACABAMENTO DE REGISTRO BASE CELITE 1.1/4, 1.1/2 LIFE PLUS (COMPATÍVEL COM A BASE DE REGISTRO DOCOL E CELITE DE 20 ESTRIAS)</p> <p>CROMADO<br/>Caixa master: 2</p> |

|   |                   |   |
|---|-------------------|---|
|     | <p>B5006C0CRB</p> | <p>ACABAMENTO DE REGISTRO BASE CELITE 1/2, 3/4, 1 LIFE PLUS (COMPATÍVEL COM A BASE DE REGISTRO DOCOL E CELITE DE 20 ESTRIAS)</p> <p>CROMADO<br/>Caixa master: 3</p>     |
|    | <p>B5007C0CRB</p> | <p>ACABAMENTO DE REGISTRO BASE REFORMA 1.1/4, 1.1/2 LIFE PLUS (COMPATÍVEL COM A BASE DE REGISTRO DECA E SIMILARES DE 16 ESTRIAS)</p> <p>CROMADO<br/>Caixa master: 2</p> |
|    | <p>B5005C0CRB</p> | <p>ACABAMENTO DE REGISTRO BASE REFORMA 1/2, 3/4, 1 LIFE PLUS (COMPATÍVEL COM A BASE DE REGISTRO DECA E SIMILARES DE 16 ESTRIAS)</p> <p>CROMADO<br/>Caixa master: 3</p>  |
|   | <p>B5009C0CRB</p> | <p>MISTURADOR PARA COZINHA DE MESA BICA MÓVEL COM AREJADOR ARTICULADO LIFE PLUS</p> <p>CROMADO<br/>Caixa master: 2</p>  |
|  | <p>B5010C0CRB</p> | <p>MISTURADOR PARA COZINHA DE PAREDE BICA MÓVEL COM AREJADOR ARTICULADO LIFE PLUS</p> <p>CROMADO<br/>Caixa master: 2</p>  |
|  | <p>B5011C0CRB</p> | <p>TORNEIRA PARA COZINHA DE MESA BICA ALTA MÓVEL COM AREJADOR ARTICULADO LIFE PLUS</p> <p>CROMADO<br/>Caixa master: 2</p>   |









B5012C0CRB

TORNEIRA PARA COZINHA DE PAREDE BICA  
MÓVEL COM AREJADOR ARTICULADO LIFE  
PLUS

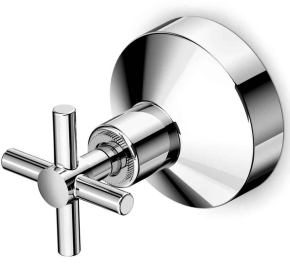

CROMADO  
Caixa master: 2

LIFE

| IMAGEM  | CÓDIGO            | DESCRIÇÃO   |
|---|-------------------|---|
|    | <p>B5799C1CR1</p> | <p>MISTURADOR PARA LAVATORIO DE MESA 3 FUIROS BICA ALTA COM VALVULA DE ESCOAMENTO LIFE</p> <p>CROMADO<br/>Caixa master: 2</p> |
|    | <p>B5801C1CR1</p> | <p>MISTURADOR PARA LAVATORIO DE PAREDE COM VALVULA DE ESCOAMENTO LIFE</p> <p>CROMADO<br/>Caixa master: 2</p>                  |
|   | <p>B5810C1CR1</p> | <p>TORNEIRA PARA LAVATORIO DE MESA BICA ALTA LIFE</p> <p>CROMADO<br/>Caixa master: 2</p>                                      |
|  | <p>B5811C1CR1</p> | <p>TORNEIRA PARA LAVATORIO DE MESA BICA BAIXA LIFE</p> <p>CROMADO<br/>Caixa master: 2</p>                                     |
|  | <p>B5812C1CR1</p> | <p>TORNEIRA PARA LAVATORIO DE PAREDE LIFE</p> <p>CROMADO<br/>Caixa master: 2</p>  |
|  | <p>B5845C1CR1</p> | <p>DUCHA HIGIÊNICA COM DERIVAÇÃO LIFE</p> <p>CROMADO<br/>Caixa master: 2</p>  |

|   |                   |  |
|---|-------------------|--|
|     | <p>B5000C1CRB</p> | <p>ACABAMENTO DE REGISTRO BASE CELITE 1.1/4, 1.1/2 LIFE (COMPATÍVEL COM A BASE DE REGISTRO DOCOL E CELITE DE 20 ESTRIAS)</p> <p>CROMADO<br/>Caixa master: 2</p>    |
|    | <p>B5978C1CR1</p> | <p>ACABAMENTO DE REGISTRO BASE CELITE 1/2, 3/4, 1 LIFE (COMPATÍVEL COM A BASE DE REGISTRO DOCOL E CELITE DE 20 ESTRIAS)</p> <p>CROMADO<br/>Caixa master: 3</p>     |
|    | <p>B5980C1CRB</p> | <p>ACABAMENTO DE REGISTRO BASE REFORMA 1.1/4, 1.1/2 LIFE (COMPATÍVEL COM A BASE DE REGISTRO DECA E SIMILARES DE 16 ESTRIAS)</p> <p>CROMADO<br/>Caixa master: 2</p> |
|   | <p>B5979C1CR1</p> | <p>ACABAMENTO DE REGISTRO BASE REFORMA 1/2, 3/4, 1 LIFE (COMPATÍVEL COM A BASE DE REGISTRO DECA E SIMILARES DE 16 ESTRIAS)</p> <p>CROMADO<br/>Caixa master: 3</p>  |
|  | <p>B5808C1CR1</p> | <p>MISTURADOR PARA COZINHA DE MESA BICA MÓVEL COM AREJADOR ARTICULADO LIFE</p> <p>CROMADO<br/>Caixa master: 2</p>  |
|  | <p>B5809C1CR1</p> | <p>MISTURADOR PARA COZINHA DE PAREDE BICA MÓVEL COM AREJADOR ARTICULADO LIFE</p> <p>CROMADO<br/>Caixa master: 2</p>  |



|   |                   |  |
|---|-------------------|--|
|   | <p>B5814C1CR1</p> | <p>TORNEIRA PARA COZINHA DE MESA BICA ALTA<br/>MÓVEL COM AREJADOR ARTICULADO LIFE</p> <p>CROMADO<br/>Caixa master: 2</p> |
|  | <p>B5815C1CR1</p> | <p>TORNEIRA PARA COZINHA DE PAREDE BICA<br/>MÓVEL COM AREJADOR ARTICULADO LIFE</p> <p>CROMADO<br/>Caixa master: 2</p>    |
|  | <p>B5001C1CRB</p> | <p>CHUVEIRO COM BRAÇO DE PAREDE<br/>REDONDO 220 MM LIFE</p> <p>CROMADO<br/>Caixa master: 2</p>                           |

**BASIC**

| IMAGEM  | CÓDIGO            | DESCRIÇÃO   |
|---|-------------------|---|
|    | <p>B5020C7CR0</p> | <p>MONOCOMANDO PARA LAVATORIO DE MESA<br/>BICA ALTA BASIC</p> <p>CROMADO</p>  |
|    | <p>B5019C7CR0</p> | <p>MONOCOMANDO PARA LAVATORIO DE MESA<br/>BICA BAIXA BASIC</p> <p>CROMADO</p>   |
|   | <p>B5006C7CRB</p> | <p>MISTURADOR PARA LAVATORIO DE MESA 3<br/>FUROS BICA ALTA COM VALVULA DE<br/>ESCOAMENTO BASIC</p> <p>CROMADO<br/>Caixa master: 2</p> |
|  | <p>B5001C7CRB</p> | <p>TORNEIRA PARA LAVATORIO DE MESA BICA<br/>ALTA BASIC</p> <p>CROMADO<br/>Caixa master: 3</p>   |
|  | <p>B5000C7CRB</p> | <p>TORNEIRA PARA LAVATORIO DE MESA BICA<br/>BAIXA BASIC</p> <p>CROMADO<br/>Caixa master: 3</p>  |
|  | <p>B5003C7CRB</p> | <p>TORNEIRA PARA LAVATORIO DE PAREDE<br/>BASIC</p> <p>CROMADO<br/>Caixa master: 3</p>   |

|   |                   |   |
|---|-------------------|---|
|     | <p>B5007C7CRB</p> | <p>DUCHA HIGIÊNICA COM DERIVAÇÃO BASIC</p> <p>CROMADO<br/>Caixa master: 2</p>   |
|    | <p>B5011C7CRB</p> | <p>ACABAMENTO DE REGISTRO BASE CELITE 1.1/4, 1.1/2 BASIC (COMPATÍVEL COM A BASE DE REGISTRO DOCOL E CELITE DE 20 ESTRIAS)</p> <p>CROMADO<br/>Caixa master: 2</p>    |
|    | <p>B5009C7CRB</p> | <p>ACABAMENTO DE REGISTRO BASE CELITE 1/2, 3/4, 1 BASIC (COMPATÍVEL COM A BASE DE REGISTRO DOCOL E CELITE DE 20 ESTRIAS)</p> <p>CROMADO<br/>Caixa master: 4</p>     |
|  | <p>B5010C7CRB</p> | <p>ACABAMENTO DE REGISTRO BASE REFORMA 1.1/4, 1.1/2 BASIC (COMPATÍVEL COM A BASE DE REGISTRO DECA E SIMILARES DE 16 ESTRIAS)</p> <p>CROMADO<br/>Caixa master: 2</p> |
|  | <p>B5008C7CRB</p> | <p>ACABAMENTO DE REGISTRO BASE REFORMA 1/2, 3/4, 1 BASIC (COMPATÍVEL COM A BASE DE REGISTRO DECA E SIMILARES DE 16 ESTRIAS)</p> <p>CROMADO<br/>Caixa master: 4</p>  |
|  | <p>B5021C7CR0</p> | <p>MONOCOMANDO PARA COZINHA DE MESA BICA ALTA COM AREJADOR ARTICULADO BASIC</p> <p>CROMADO</p>  |

|   |  |  |
|---|--|--|
|   |  | TORNEIRA PARA COZINHA DE MESA BICA ALTA<br>COM AREJADOR ARTICULADO BASIC |
|  |  | TORNEIRA PARA COZINHA DE PAREDE COM<br>AREJADOR ARTICULADO BASIC         |
| B5004C7CRB  |  | CROMADO<br>Caixa master: 3   |
| B5005C7CRB  |  | CROMADO<br>Caixa master: 3   |

**DESIGN**

| IMAGEM   | CÓDIGO            | DESCRIÇÃO   |
|--|-------------------|---|
|   | <p>B5007CGCRB</p> | <p>TORNEIRA PARA LAVATORIO DE MESA BICA ALTA DESIGN</p> <p>CROMADO</p>  |
|   | <p>B5008CGCRB</p> | <p>TORNEIRA PARA LAVATORIO DE MESA BICA BAIXA DESIGN</p> <p>CROMADO</p> |
|  | <p>B5006CGCRB</p> | <p>TORNEIRA PARA LAVATORIO DE PAREDE DESIGN</p> <p>CROMADO</p>          |







CITY

| IMAGEM  | CÓDIGO     | DESCRIÇÃO   |
|---|------------|---|
|    | B5799C2CRB | <p>MISTURADOR PARA LAVATORIO DE MESA 3 FUOS BICA ALTA COM VALVULA DE ESCOAMENTO CITY</p> <p>CROMADO<br/>Caixa master: 2</p>                                     |
|    | B5810C2CRB | <p>TORNEIRA PARA LAVATORIO DE MESA BICA ALTA CITY</p> <p>CROMADO<br/>Caixa master: 3</p>  |
|   | B5811C2CRB | <p>TORNEIRA PARA LAVATORIO DE MESA BICA BAIXA CITY</p> <p>CROMADO<br/>Caixa master: 3</p>   |
|  | B5846C2CRB | <p>DUCHA HIGIÊNICA COM DERIVAÇÃO CITY</p> <p>CROMADO<br/>Caixa master: 3</p>  |
|  | B5000C2CRB | <p>ACABAMENTO DE REGISTRO BASE CELITE 1.1/4, 1.1/2 CITY (COMPATÍVEL COM A BASE DE REGISTRO DOCOL E CELITE DE 20 ESTRIAS)</p> <p>CROMADO<br/>Caixa master: 2</p> |
|  | B5978C2CRB | <p>ACABAMENTO DE REGISTRO BASE CELITE 1/2, 3/4, 1 CITY (COMPATÍVEL COM A BASE DE REGISTRO DOCOL E CELITE DE 20 ESTRIAS)</p> <p>CROMADO<br/>Caixa master: 4</p>  |

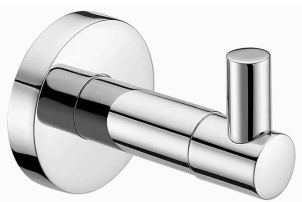
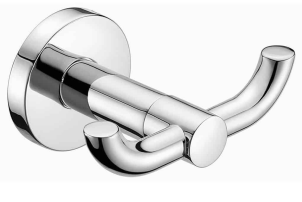
|   |                   |  |
|---|-------------------|--|
|     | <p>B5980C2CRB</p> | <p>ACABAMENTO DE REGISTRO BASE REFORMA 1.1/4, 1.1/2 CITY (COMPATÍVEL COM A BASE DE REGISTRO DECA E SIMILARES DE 16 ESTRIAS)</p> <p>CROMADO<br/>Caixa master: 2</p> |
|    | <p>B5979C2CRB</p> | <p>ACABAMENTO DE REGISTRO BASE REFORMA 1/2, 3/4, 1 CITY (COMPATÍVEL COM A BASE DE REGISTRO DECA E SIMILARES DE 16 ESTRIAS)</p> <p>CROMADO<br/>Caixa master: 4</p>  |
|    | <p>B5808C2CRB</p> | <p>MISTURADOR PARA COZINHA DE MESA BICA MÓVEL COM AREJADOR ARTICULADO CITY</p> <p>CROMADO<br/>Caixa master: 2</p>  |
|  | <p>B5809C2CRB</p> | <p>MISTURADOR PARA COZINHA DE PAREDE BICA MÓVEL COM AREJADOR ARTICULADO CITY</p> <p>CROMADO<br/>Caixa master: 2</p>  |
|  | <p>B5814C2CRB</p> | <p>TORNEIRA PARA COZINHA DE MESA BICA ALTA MÓVEL COM AREJADOR ARTICULADO CITY</p> <p>CROMADO<br/>Caixa master: 3</p>   |
|  | <p>B5815C2CRB</p> | <p>TORNEIRA PARA COZINHA DE PAREDE BICA MÓVEL COM AREJADOR ARTICULADO CITY</p> <p>CROMADO<br/>Caixa master: 3</p>  |



|   |                   |   |
|---|-------------------|---|
|     | <p>B8000C2CR0</p> | <p>CABIDE CITY</p> <p>CROMADO<br/>Caixa master: 4</p>                 |
|    | <p>B8001C2CR0</p> | <p>CABIDE DUPLO CITY</p> <p>CROMADO<br/>Caixa master: 4</p>           |
|    | <p>B8003C2CR0</p> | <p>PAPELEIRA CITY</p> <p>CROMADO<br/>Caixa master: 3</p>              |
|   | <p>B8004C2CR0</p> | <p>TOALHEIRO ANEL CITY</p> <p>CROMADO<br/>Caixa master: 3</p>         |
|  | <p>B8005C2CR0</p> | <p>TOALHEIRO BARRA 600 MM CITY</p> <p>CROMADO<br/>Caixa master: 3</p> |
|  | <p>B8002C2CR0</p> | <p>SABONETEIRA CITY</p> <p>CROMADO<br/>Caixa master: 3</p>            |









B8007C2CR0

KIT ACESSÓRIOS 5 PEÇAS CITY | PAPELEIRA,  
SABONETEIRA, TOALHEIRO ANEL, CABIDE E  
TOLAHEIRO BARRA 600MM.

CROMADO  
Caixa master: 2

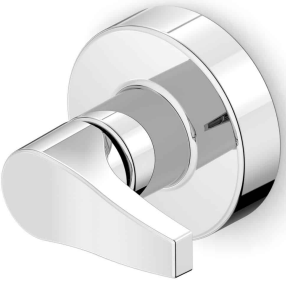



LIKE

| IMAGEM  | CÓDIGO     | DESCRIÇÃO   |
|---|------------|---|
|    |            | MISTURADOR PARA LAVATORIO DE MESA 3 FUOS BICA ALTA COM VALVULA DE ESCOAMENTO FIT                                      |
|   | B5004CYCRB | CROMADO   |
|    |            | TORNEIRA PARA LAVATORIO DE MESA BICA ALTA LIKE  |
|   | B5001CYCRB | CROMADO   |
|   |            | DUCHA HIGIÊNICA COM DERIVAÇÃO LIKE  |
|   | B5005CYCRB | CROMADO   |
|  |            | ACABAMENTO DE REGISTRO BASE CELITE 1.1/4, 1.1/2 LIKE (COMPATÍVEL COM A BASE DE REGISTRO DOCOL E CELITE DE 20 ESTRIAS) |
|   | B5008CYCRB | CROMADO   |
|  |            | ACABAMENTO DE REGISTRO BASE CELITE 1/2, 3/4, 1 LIKE (COMPATÍVEL COM A BASE DE REGISTRO DOCOL E CELITE DE 20 ESTRIAS)  |
|   | B5006CYCRB | CROMADO   |
|  |            | ACABAMENTO DE REGISTRO BASE FABRIMAR 1/2, 3/4, 1 LIKE (COMPATÍVEL COM A BASE DE REGISTRO FABRIMAR DE 19 ESTRIAS)      |
|   | B5003CYCRB | CROMADO   |

|   |                   |  |
|---|-------------------|--|
|     | <p>B5009CYCRB</p> | <p>ACABAMENTO DE REGISTRO BASE REFORMA 1.1/4, 1.1/2 LIKE (COMPATÍVEL COM A BASE DE REGISTRO DECA E SIMILARES DE 16 ESTRIAS)</p> <p>CROMADO</p> |
|    | <p>B5007CYCRB</p> | <p>ACABAMENTO DE REGISTRO BASE REFORMA 1/2, 3/4, 1 LIKE (COMPATÍVEL COM A BASE DE REGISTRO DECA E SIMILARES DE 16 ESTRIAS)</p> <p>CROMADO</p>  |
|    | <p>B5010CYCRB</p> | <p>MISTURADOR PARA COZINHA DE MESA BICA MÓVEL COM AREJADOR ARTICULADO LIKE</p> <p>CROMADO</p>  |
|  | <p>B5011CYCRB</p> | <p>MISTURADOR PARA COZINHA DE PAREDE BICA MÓVEL COM AREJADOR ARTICULADO LIKE</p> <p>CROMADO</p>  |
|  | <p>B5012CYCRB</p> | <p>TORNEIRA PARA COZINHA DE MESA BICA ALTA MÓVEL COM AREJADOR ARTICULADO LIKE</p> <p>CROMADO</p>   |
|  | <p>B5013CYCRB</p> | <p>TORNEIRA PARA COZINHA DE PAREDE BICA MÓVEL COM AREJADOR ARTICULADO LIKE</p> <p>CROMADO</p>  |

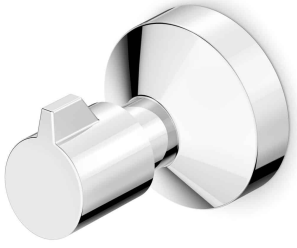
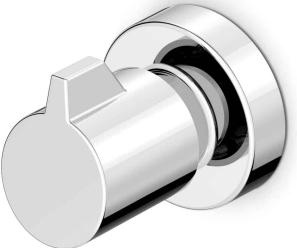



**FIT**

| IMAGEM  | CÓDIGO            | DESCRIÇÃO  |
|---|-------------------|--|
|    | <p>B5004CNCRB</p> | <p>MISTURADOR PARA LAVATORIO DE MESA 3 FUROS BICA ALTA COM VALVULA DE ESCOAMENTO FIT</p> <p>CROMADO<br/>Caixa master: 2</p>                                    |
|    | <p>B5005CNCRB</p> | <p>TORNEIRA PARA LAVATORIO DE MESA BICA ALTA FIT</p> <p>CROMADO<br/>Caixa master: 3</p>  |
|   | <p>B5006CNCRB</p> | <p>TORNEIRA PARA LAVATORIO DE MESA BICA BAIXA FIT</p> <p>CROMADO<br/>Caixa master: 3</p>   |
|  | <p>B5007CNCRB</p> | <p>DUCHA HIGIÊNICA COM DERIVAÇÃO FIT</p> <p>CROMADO<br/>Caixa master: 3</p>  |
|  | <p>B5002CNCRB</p> | <p>ACABAMENTO DE REGISTRO BASE CELITE 1.1/4, 1.1/2 FIT (COMPATÍVEL COM A BASE DE REGISTRO DOCOL E CELITE DE 20 ESTRIAS)</p> <p>CROMADO<br/>Caixa master: 2</p> |
|  | <p>B5001CNCRB</p> | <p>ACABAMENTO DE REGISTRO BASE CELITE 1/2, 3/4, 1 FIT (COMPATÍVEL COM A BASE DE REGISTRO DOCOL E CELITE DE 20 ESTRIAS)</p> <p>CROMADO<br/>Caixa master: 4</p>  |



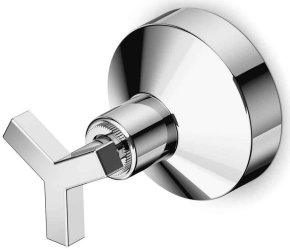
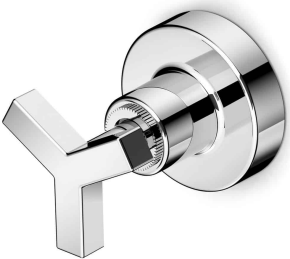



|   |                   |   |
|---|-------------------|---|
|     | <p>B5003CNCRB</p> | <p>ACABAMENTO DE REGISTRO BASE REFORMA<br/>1.1/4, 1.1/2 FIT (COMPATÍVEL COM A BASE DE<br/>REGISTRO DECA E SIMILARES DE 16 ESTRIAS)</p> <p>CROMADO<br/>Caixa master: 2</p> |
|    | <p>B5000CNCRB</p> | <p>ACABAMENTO DE REGISTRO BASE REFORMA<br/>1/2, 3/4, 1 FIT (COMPATÍVEL COM A BASE DE<br/>REGISTRO DECA E SIMILARES DE 16 ESTRIAS)</p> <p>CROMADO<br/>Caixa master: 4</p>  |
|    | <p>B5008CNCRB</p> | <p>MISTURADOR PARA COZINHA DE MESA BICA<br/>MÓVEL COM AREJADOR ARTICULADO FIT</p> <p>CROMADO<br/>Caixa master: 2</p>  |
|  | <p>B5009CNCRB</p> | <p>MISTURADOR PARA COZINHA DE PAREDE BICA<br/>MÓVEL COM AREJADOR ARTICULADO FIT</p> <p>CROMADO<br/>Caixa master: 2</p>  |
|  | <p>B5010CNCRB</p> | <p>TORNEIRA PARA COZINHA DE MESA BICA ALTA<br/>MÓVEL COM AREJADOR ARTICULADO FIT</p> <p>CROMADO<br/>Caixa master: 3</p>   |
|  | <p>B5011CNCRB</p> | <p>TORNEIRA PARA COZINHA DE PAREDE BICA<br/>MÓVEL COM AREJADOR ARTICULADO FIT</p> <p>CROMADO<br/>Caixa master: 3</p>  |

UP

| IMAGEM  | CÓDIGO     | DESCRIÇÃO   |
|---|------------|---|
|    | B5004CLCRB | <p>MISTURADOR PARA LAVATORIO DE MESA 3 FUROS BICA ALTA COM VALVULA DE ESCOAMENTO UP</p> <p>CROMADO<br/>Caixa master: 2</p>                                    |
|    | B5006CLCRB | <p>TORNEIRA PARA LAVATORIO DE MESA BICA ALTA UP</p> <p>CROMADO<br/>Caixa master: 3</p>  |
|   | B5007CLCRB | <p>TORNEIRA PARA LAVATORIO DE MESA BICA BAIXA UP</p> <p>CROMADO<br/>Caixa master: 3</p>   |
|  | B5008CLCRB | <p>DUCHA HIGIÊNICA COM DERIVAÇÃO UP</p> <p>CROMADO<br/>Caixa master: 3</p>  |
|  | B5003CLCRB | <p>ACABAMENTO DE REGISTRO BASE CELITE 1.1/4, 1.1/2 UP (COMPATÍVEL COM A BASE DE REGISTRO DOCOL E CELITE DE 20 ESTRIAS)</p> <p>CROMADO<br/>Caixa master: 2</p> |
|  | B5001CLCRB | <p>ACABAMENTO DE REGISTRO BASE CELITE 1/2, 3/4, 1 UP (COMPATÍVEL COM A BASE DE REGISTRO DOCOL E CELITE DE 20 ESTRIAS)</p> <p>CROMADO<br/>Caixa master: 4</p>  |

|   |                   |  |
|---|-------------------|--|
|     | <p>B5023CLCRB</p> | <p>ACABAMENTO DE REGISTRO BASE FABRIMAR<br/>1/2, 3/4, 1 UP (COMPATÍVEL COM A BASE DE<br/>REGISTRO FABRIMAR DE 19 ESTRIAS)</p> <p>CROMADO</p>                             |
|    | <p>B5002CLCRB</p> | <p>ACABAMENTO DE REGISTRO BASE REFORMA<br/>1.1/4, 1.1/2 UP (COMPATÍVEL COM A BASE DE<br/>REGISTRO DECA E SIMILARES DE 16 ESTRIAS)</p> <p>CROMADO<br/>Caixa master: 2</p> |
|    | <p>B5000CLCRB</p> | <p>ACABAMENTO DE REGISTRO BASE REFORMA<br/>1/2, 3/4, 1 UP (COMPATÍVEL COM A BASE DE<br/>REGISTRO DECA E SIMILARES DE 16 ESTRIAS)</p> <p>CROMADO<br/>Caixa master: 4</p>  |
|   | <p>B5009CLCRB</p> | <p>MISTURADOR PARA COZINHA DE MESA BICA<br/>MÓVEL COM AREJADOR ARTICULADO UP</p> <p>CROMADO<br/>Caixa master: 2</p>  |
|  | <p>B5010CLCRB</p> | <p>MISTURADOR PARA COZINHA DE PAREDE BICA<br/>MÓVEL COM AREJADOR ARTICULADO UP</p> <p>CROMADO<br/>Caixa master: 2</p>  |
|  | <p>B5011CLCRB</p> | <p>TORNEIRA PARA COZINHA DE MESA BICA ALTA<br/>MÓVEL COM AREJADOR ARTICULADO UP</p> <p>CROMADO<br/>Caixa master: 3</p>   |









|   |                   |   |
|---|-------------------|---|
|     | <p>B5012CLCRB</p> | <p>TORNEIRA PARA COZINHA DE PAREDE BICA MÓVEL COM AREJADOR ARTICULADO UP</p> <p>CROMADO<br/>Caixa master: 3</p> |
|    | <p>B5015CLCRB</p> | <p>TORNEIRA PARA TANQUE E JARDIM DE PAREDE COM BICO UNIÃO PLÁSTICO UP</p> <p>CROMADO<br/>Caixa master: 4</p>    |
|    | <p>B5014CLCRB</p> | <p>TORNEIRA PARA TANQUE E MÁQUINA DE PAREDE UP</p> <p>CROMADO<br/>Caixa master: 3</p>                           |
|  | <p>B5013CLCRB</p> | <p>TORNEIRA PARA PIA E TANQUE DE PAREDE UP</p> <p>CROMADO<br/>Caixa master: 4</p>                               |
|  | <p>B5016CLCR0</p> | <p>CABIDE UP</p> <p>CROMADO</p>   |
|  | <p>B5020CLCR0</p> | <p>PAPELEIRA UP</p> <p>CROMADO</p>  |

|   |                   |  |
|---|-------------------|--|
|     |                   | <p>TOALHEIRO ANEL UP</p>   |
|   | <p>B5017CLCR0</p> | <p>CROMADO</p>   |
|    |                   | <p>TOALHEIRO BARRA 600 MM UP</p>   |
|   | <p>B5018CLCR0</p> | <p>CROMADO</p>   |
|    |                   | <p>SABONETEIRA UP</p>  |
|   | <p>B5019CLCR0</p> | <p>CROMADO</p>   |
|  |                   | <p>PRATELEIRA 400 MM UP</p>  |
|   | <p>B5021CLCR0</p> | <p>CROMADO</p>   |
|  |                   | <p>KIT ACESSÓRIOS 5 PEÇAS UP   PAPELEIRA, SABONETEIRA, TOALHEIRO ANEL, CABIDE E TOALHEIRO BARRA 600MM.</p> |
|   | <p>B5022CLCR0</p> | <p>CROMADO</p>   |







SMART - N

| IMAGEM  | CÓDIGO     | DESCRIÇÃO   |
|---|------------|---|
|    | B5001CCRB  | MISTURADOR PARA LAVATORIO DE MESA 3 FUOS BICA ALTA COM VALVULA DE ESCOAMENTO SMART-N<br>CROMADO                                       |
|    | B50011CCRB | TORNEIRA PARA LAVATORIO DE MESA BICA ALTA SMART - N<br>CROMADO  |
|   | B50021CCRB | DUCHA HIGIÊNICA COM DERIVAÇÃO SMART - N<br>CROMADO  |
|  | B50031CCRB | DUCHA HIGIENICA SEM DERIVAÇÃO COM FLEXÍVEL PVC SMART - N<br>CROMADO   |
|  | B50071CCRB | ACABAMENTO DE REGISTRO BASE CELITE 1.1/4, 1.1/2 SMART - N (COMPATÍVEL COM A BASE DE REGISTRO DOCOL E CELITE DE 20 ESTRIAS)<br>CROMADO |
|  | B50041CCRB | ACABAMENTO DE REGISTRO BASE CELITE 1/2, 3/4, 1 SMART - N (COMPATÍVEL COM A BASE DE REGISTRO DOCOL E CELITE DE 20 ESTRIAS)<br>CROMADO  |

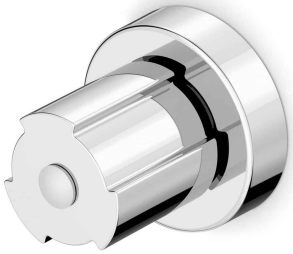
|   |                   |   |
|---|-------------------|---|
|     | <p>B50081CCRB</p> | <p>ACABAMENTO DE REGISTRO BASE REFORMA 1.1/4, 1.1/2 SMART - N (COMPATÍVEL COM A BASE DE REGISTRO DECA E SIMILARES DE 16 ESTRIAS)</p> <p>CROMADO</p> |
|    | <p>B50051CCRB</p> | <p>ACABAMENTO DE REGISTRO BASE REFORMA 1/2, 3/4, 1 SMART - N (COMPATÍVEL COM A BASE DE REGISTRO DECA E SIMILARES DE 16 ESTRIAS)</p> <p>CROMADO</p>  |
|    | <p>B50091CCRB</p> | <p>MISTURADOR PARA COZINHA DE MESA BICA MÓVEL COM AREJADOR ARTICULADO SMART - N</p> <p>CROMADO</p>  |
|  | <p>B50101CCRB</p> | <p>MISTURADOR PARA COZINHA DE PAREDE BICA MÓVEL COM AREJADOR ARTICULADO SMART - N</p> <p>CROMADO</p>  |
|  | <p>B50111CCRB</p> | <p>TORNEIRA PARA COZINHA DE MESA BICA ALTA MÓVEL COM AREJADOR SMART - N</p> <p>CROMADO</p>  |
|  | <p>B50121CCRB</p> | <p>TORNEIRA PARA COZINHA DE PAREDE BICA MÓVEL 90° COM AREJADOR ARTICULADO SMART - N</p> <p>CROMADO</p>  |

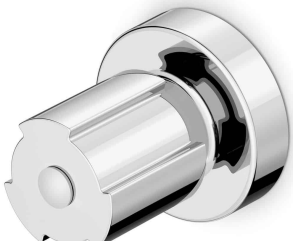
SMART

| IMAGEM  | CÓDIGO     | DESCRIÇÃO  |
|---|------------|--|
|    | B5006CMCRB | MISTURADOR PARA LAVATORIO DE MESA 3 FUROS BICA ALTA COM VALVULA DE ESCOAMENTO SMART<br><br>CROMADO<br>Caixa master: 2                                    |
|    | B5007CMCRB | TORNEIRA PARA LAVATORIO DE MESA BICA ALTA SMART<br><br>CROMADO<br>Caixa master: 4  |
|   | B5008CMCRB | TORNEIRA PARA LAVATORIO DE MESA BICA BAIXA SMART<br><br>CROMADO<br>Caixa master: 4   |
|  | B5004CMCRB | DUCHA HIGIÊNICA COM DERIVAÇÃO SMART<br><br>CROMADO<br>Caixa master: 4  |
|  | B5005CMCRB | DUCHA HIGIENICA SEM DERIVAÇÃO COM FLEXÍVEL PVC SMART<br><br>CROMADO<br>Caixa master: 4   |
|  | B5002CMCRB | ACABAMENTO DE REGISTRO BASE CELITE 1.1/4, 1.1/2 SMART (COMPATÍVEL COM A BASE DE REGISTRO DOCOL E CELITE DE 20 ESTRIAS)<br><br>CROMADO<br>Caixa master: 3 |







|   |                   |   |
|---|-------------------|---|
|     | <p>B5003CMCRB</p> | <p>ACABAMENTO DE REGISTRO BASE CELITE 1/2, 3/4, 1 SMART (COMPATÍVEL COM A BASE DE REGISTRO DOCOL E CELITE DE 20 ESTRIAS)</p> <p>CROMADO<br/>Caixa master: 6</p>     |
|    | <p>B5000CMCRB</p> | <p>ACABAMENTO DE REGISTRO BASE REFORMA 1.1/4, 1.1/2 SMART (COMPATÍVEL COM A BASE DE REGISTRO DECA E SIMILARES DE 16 ESTRIAS)</p> <p>CROMADO<br/>Caixa master: 3</p> |
|    | <p>B5001CMCRB</p> | <p>ACABAMENTO DE REGISTRO BASE REFORMA 1/2, 3/4, 1 SMART (COMPATÍVEL COM A BASE DE REGISTRO DECA E SIMILARES DE 16 ESTRIAS)</p> <p>CROMADO<br/>Caixa master: 6</p>  |
|   | <p>B5009CMCRB</p> | <p>MISTURADOR PARA COZINHA DE MESA BICA MÓVEL COM AREJADOR ARTICULADO SMART</p> <p>CROMADO<br/>Caixa master: 2</p>  |
|  | <p>B5010CMCRB</p> | <p>MISTURADOR PARA COZINHA DE PAREDE BICA MÓVEL COM AREJADOR ARTICULADO SMART</p> <p>CROMADO<br/>Caixa master: 2</p>  |
|  | <p>B5011CMCRB</p> | <p>TORNEIRA PARA COZINHA DE MESA BICA ALTA MÓVEL COM AREJADOR SMART</p> <p>CROMADO<br/>Caixa master: 4</p>  |







|   |                   |   |
|---|-------------------|---|
|     | <p>B5012CMCRB</p> | <p>TORNEIRA PARA COZINHA DE PAREDE BICA MÓVEL COM AREJADOR SMART</p> <p>CROMADO<br/>Caixa master: 4</p> |
|    | <p>B5013CMCRB</p> | <p>CHUVEIRO COM BRAÇO DE PAREDE REDONDO 80 MM SMART</p> <p>CROMADO<br/>Caixa master: 2</p>              |
|    | <p>B5015CMCRB</p> | <p>CHUVEIRO 80MM COM DESVIADOR COM DUCHA MANUAL SMART</p> <p>CROMADO<br/>Caixa master: 2</p>            |
|  | <p>B5014CMCRB</p> | <p>DUCHA MANUAL 80 MM COM DESVIADOR SMART</p> <p>CROMADO<br/>Caixa master: 2</p>                        |

**CELITE ONE**





| IMAGEM  | CÓDIGO            | DESCRIÇÃO   |
|---|-------------------|---|
|    | <p>B5000CKCRB</p> | <p>MISTURADOR PARA LAVATORIO DE MESA 3 FUROS BICA ALTA COM VALVULA DE ESCOAMENTO CELITE ONE</p> <p>CROMADO<br/>Caixa master: 2</p>                                    |
|    | <p>B5001CKCR3</p> | <p>TORNEIRA PARA LAVATORIO DE MESA BICA ALTA CELITE ONE</p> <p>CROMADO<br/>Caixa master: 4</p>  |
|   | <p>B5002CKCR3</p> | <p>TORNEIRA PARA LAVATORIO DE MESA BICA BAIXA CELITE ONE</p> <p>CROMADO<br/>Caixa master: 4</p>   |
|  | <p>B5004CKCR3</p> | <p>DUCHA HIGIÊNICA COM DERIVAÇÃO CELITE ONE</p> <p>CROMADO<br/>Caixa master: 4</p>  |
|  | <p>B5003CKCR3</p> | <p>DUCHA HIGIENICA SEM DERIVAÇÃO CELITE ONE</p> <p>CROMADO<br/>Caixa master: 4</p>  |
|  | <p>B5012CKCR3</p> | <p>ACABAMENTO DE REGISTRO BASE CELITE 1.1/4, 1.1/2 CELITE ONE (COMPATÍVEL COM A BASE DE REGISTRO DOCOL E CELITE DE 20 ESTRIAS)</p> <p>CROMADO<br/>Caixa master: 3</p> |







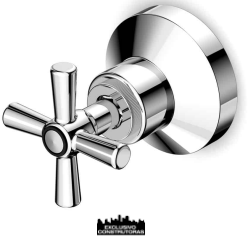

|   |                   |  |
|---|-------------------|--|
|     | <p>B5011CKCR3</p> | <p>ACABAMENTO DE REGISTRO BASE CELITE 1/2, 3/4, 1 CELITE ONE (COMPATÍVEL COM A BASE DE REGISTRO DOCOL E CELITE DE 20 ESTRIAS)</p> <p>CROMADO<br/>Caixa master: 6</p>     |
|    | <p>B5016CKCR3</p> | <p>ACABAMENTO DE REGISTRO BASE FABRIMAR 1/2, 3/4, 1 CELITE ONE (COMPATÍVEL COM A BASE DE REGISTRO FABRIMAR DE 19 ESTRIAS)</p> <p>CROMADO</p>                             |
|    | <p>B5013CKCR3</p> | <p>ACABAMENTO DE REGISTRO BASE REFORMA 1.1/4, 1.1/2 CELITE ONE (COMPATÍVEL COM A BASE DE REGISTRO DECA E SIMILARES DE 16 ESTRIAS)</p> <p>CROMADO<br/>Caixa master: 3</p> |
|   | <p>B5010CKCR3</p> | <p>ACABAMENTO DE REGISTRO BASE REFORMA 1/2, 3/4, 1 CELITE ONE (COMPATÍVEL COM A BASE DE REGISTRO DECA E SIMILARES DE 16 ESTRIAS)</p> <p>CROMADO<br/>Caixa master: 6</p>  |
|  | <p>B5014CKCRB</p> | <p>MISTURADOR PARA COZINHA DE MESA BICA MÓVEL COM AREJADOR ARTICULADO CELITE ONE</p> <p>CROMADO<br/>Caixa master: 2</p>  |
|  | <p>B5015CKCRB</p> | <p>MISTURADOR PARA COZINHA DE PAREDE BICA MÓVEL COM AREJADOR ARTICULADO CELITE ONE</p> <p>CROMADO<br/>Caixa master: 2</p>  |

|   |                   |   |
|---|-------------------|---|
|     | <p>B5009CKCR3</p> | <p>TORNEIRA PARA COZINHA DE MESA BICA ALTA<br/>MÓVEL COM AREJADOR CELITE ONE</p> <p>CROMADO<br/>Caixa master: 4</p>                                 |
|    | <p>B5008CKCR3</p> | <p>TORNEIRA PARA COZINHA DE PAREDE BICA<br/>MÓVEL COM AREJADOR CELITE ONE</p> <p>CROMADO<br/>Caixa master: 4</p>                                    |
|    | <p>B5007CKCR3</p> | <p>TORNEIRA PARA TANQUE E JARDIM DE<br/>PAREDE COM BICO UNIÃO PLÁSTICO CELITE<br/>ONE</p> <p>CROMADO<br/>Caixa master: 4</p>                        |
|   | <p>B5006CKCR3</p> | <p>TORNEIRA PARA TANQUE E MÁQUINA DE<br/>PAREDE CELITE ONE</p> <p>CROMADO<br/>Caixa master: 3</p>   |
|  | <p>B5005CKCR3</p> | <p>TORNEIRA PARA PIA E TANQUE DE PAREDE<br/>CELITE ONE</p> <p>CROMADO<br/>Caixa master: 4</p>   |
|  | <p>B8000CKCR0</p> | <p>KIT ACESSÓRIOS 5 PEÇAS CELITE ONE  <br/>PAPELEIRA, SABONETEIRA, TOALHEIRO<br/>BARRA 180MM, CABIDE E TOALHEIRO BARRA<br/>450MM</p> <p>CROMADO</p> |







**ECO-N CELITE**

| IMAGEM  | CÓDIGO     | DESCRIÇÃO  |
|---|------------|--|
|    | B5000F2CR3 | TORNEIRA PARA LAVATÓRIO DE MESA BICA ALTA ECO-N CELITE<br>CROMADO  |
|    | B5001F2CR3 | TORNEIRA PARA LAVATÓRIO DE MESA BICA BAIXA ECO-N CELITE<br>CROMADO   |
|   | B5003CSCR3 | ACABAMENTO DE REGISTRO BASE REFORMA 1.1/4, 1.1/2 (COMPATÍVEL COM A BASE DE REGISTRO DECA E SIMILARES DE 16 ESTRIAS)<br>CROMADO |
|  | B5002CSCR3 | ACABAMENTO DE REGISTRO BASE REFORMA 1/2, 3/4, 1 (COMPATÍVEL COM A BASE DE REGISTRO DECA E SIMILARES DE 16 ESTRIAS)<br>CROMADO  |
|  | B5002F2CR3 | TORNEIRA PARA COZINHA DE MESA BICA ALTA MÓVEL COM AREJADOR ECO-N CELITE<br>CROMADO   |
|  | B5005F2CR3 | TORNEIRA PARA COZINHA DE MESA BICA MÓVEL COM SAÍDA PARA FILTRO ECO-N CELITE<br>CROMADO   |

|   |                   |   |
|---|-------------------|---|
|     | <p>B5003F2CR3</p> | <p>TORNEIRA PARA COZINHA DE PAREDE BICA MÓVEL COM AREJADOR ECO-N CELITE</p> <p>CROMADO</p>                |
|    | <p>B5006F2CR3</p> | <p>TORNEIRA PARA COZINHA DE PAREDE BICA MÓVEL COM SAÍDA PARA FILTRO ECO-N CELITE</p> <p>CROMADO</p>       |
|    | <p>B5009F2CR3</p> | <p>TORNEIRA PARA TANQUE E JARDIM 100 MM DE PAREDE COM BICO UNIÃO PLÁSTICO ECO-N CELITE</p> <p>CROMADO</p> |
|   | <p>B5010F2CR3</p> | <p>TORNEIRA PARA TANQUE E JARDIM 130 MM DE PAREDE COM BICO UNIÃO PLÁSTICO ECO-N CELITE</p> <p>CROMADO</p> |
|  | <p>B5008F2CR3</p> | <p>TORNEIRA PARA TANQUE E JARDIM 70 MM DE PAREDE COM BICO UNIÃO PLÁSTICO ECO-N CELITE</p> <p>CROMADO</p>  |
|  | <p>B5007F2CR3</p> | <p>TORNEIRA PARA TANQUE E MÁQUINA DE PAREDE ECO-N CELITE</p> <p>CROMADO</p>                               |

ECO CELITE

| IMAGEM  | CÓDIGO     | DESCRIÇÃO   |
|---|------------|---|
|    | B5000CSCR3 | TORNEIRA PARA LAVATÓRIO DE MESA BICA ALTA ECO CELITE  |
|   |            | CROMADO   |
|    | B5001CSCR3 | TORNEIRA PARA LAVATÓRIO DE MESA BICA BAIXA ECO CELITE   |
|   |            | CROMADO   |
|   | B5025CSCR3 | DUCHA HIGIENICA SEM DERIVAÇÃO ECO CELITE  |
|   |            | CROMADO   |
|  | B5003CSCR3 | ACABAMENTO DE REGISTRO BASE REFORMA 1.1/4, 1.1/2 (COMPATÍVEL COM A BASE DE REGISTRO DECA E SIMILARES DE 16 ESTRIAS) |
|   |            | CROMADO   |
|  | B5002CSCR3 | ACABAMENTO DE REGISTRO BASE REFORMA 1/2, 3/4, 1 (COMPATÍVEL COM A BASE DE REGISTRO DECA E SIMILARES DE 16 ESTRIAS)  |
|   |            | CROMADO   |
|  | B5004CSCR3 | TORNEIRA PARA COZINHA DE MESA BICA ALTA MÓVEL COM AREJADOR ECO CELITE   |
|   |            | CROMADO   |

|   |                   |   |
|---|-------------------|---|
|     | <p>B5007CSCR3</p> | <p>TORNEIRA PARA COZINHA DE MESA BICA MÓVEL COM SAÍDA PARA FILTRO ECO CELITE</p> <p>CROMADO</p>         |
|    | <p>B5005CSCR3</p> | <p>TORNEIRA PARA COZINHA DE PAREDE BICA MÓVEL COM AREJADOR ECO CELITE</p> <p>CROMADO</p>                |
|    | <p>B5008CSCR3</p> | <p>TORNEIRA PARA COZINHA DE PAREDE BICA MÓVEL COM SAÍDA PARA FILTRO ECO CELITE</p> <p>CROMADO</p>       |
|   | <p>B5011CSCR3</p> | <p>TORNEIRA PARA TANQUE E JARDIM 100 MM DE PAREDE COM BICO UNIÃO PLÁSTICO ECO CELITE</p> <p>CROMADO</p> |
|  | <p>B5012CSCR3</p> | <p>TORNEIRA PARA TANQUE E JARDIM 130 MM DE PAREDE COM BICO UNIÃO PLÁSTICO ECO CELITE</p> <p>CROMADO</p> |
|  | <p>B5010CSCR3</p> | <p>TORNEIRA PARA TANQUE E JARDIM 70 MM DE PAREDE COM BICO UNIÃO PLÁSTICO ECO CELITE</p> <p>CROMADO</p>  |





B5009CSCR3

TORNEIRA PARA TANQUE E MÁQUINA DE  
PAREDE ECO CELITE

CROMADO

**ECOPRESS**

| IMAGEM   | CÓDIGO            | DESCRIÇÃO  |
|--|-------------------|--|
|   | <p>B5000COCRB</p> | <p>TORNEIRA PARA LAVATORIO DE MESA BICA BAIXA COM FECHAMENTO AUTOMÁTICO</p> <p>CROMADO<br/>Caixa master: 2</p> |
|   | <p>B5001COCRB</p> | <p>TORNEIRA PARA LAVATORIO DE PAREDE COM FECHAMENTO AUTOMÁTICO</p> <p>CROMADO<br/>Caixa master: 2</p>          |
|  | <p>B5002COCRB</p> | <p>VÁLVULA PARA MICTORIO DE PAREDE COM FECHAMENTO AUTOMÁTICO</p> <p>CROMADO<br/>Caixa master: 2</p>            |





## ECO - CELITE

| IMAGEM  | CÓDIGO     | DESCRIÇÃO   |
|---|------------|---|
|  | B501800CR2 | TORNEIRA PARA LAVATORIO DE MESA COM<br>FECHAMENTO AUTOMÁTICO ECO-CELITE<br><br>CROMADO<br>Caixa master: 3 |



**E-ELECTRONIC**

| IMAGEM  | CÓDIGO            | DESCRIÇÃO   |
|---|-------------------|---|
|  | <p>B5001CPCR0</p> | <p>VALVULA MICTORIO ELETRONICA PAREDE<br/>AC/DC E-ELECTRONIC 2.0</p> <p>CROMADO</p> |

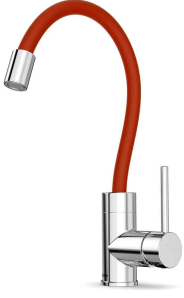

**CELITE COLORS**

| IMAGEM  | CÓDIGO            | DESCRIÇÃO  |
|---|-------------------|--|
|  | <p>B5003CECR0</p> | <p>MONOCOMANDO PARA COZINHA DE MESA<br/>BICA FLEXÍVEL PRETA CELITE COLORS</p>    |
|  | <p>B5002CECR0</p> | <p>MONOCOMANDO PARA COZINHA DE MESA<br/>BICA FLEXÍVEL VERMELHA CELITE COLORS</p> |





**GOURMET CELITE**

| IMAGEM  | CÓDIGO            | DESCRIÇÃO  |
|---|-------------------|--|
|  |                   | <p>MONOCOMANDO PARA COZINHA DE MESA<br/>BICA EXTRAÍVEL COM 2 FUNÇÕES GOURMET</p> |
|   | <p>B5000CVCR0</p> | <p>CROMADO</p>   |





**CELITE PRÁTICA**

| IMAGEM  | CÓDIGO            | DESCRIÇÃO   |
|---|-------------------|---|
|  | <p>B5001F5CR0</p> | <p>MONOCOMANDO PARA COZINHA DE MESA<br/>BICA EXTRAÍVEL "L" COM 2 FUNÇÕES PRÁTICA</p> <p>CROMADO</p> |
|  | <p>B5000F5CR0</p> | <p>MONOCOMANDO PARA COZINHA DE MESA<br/>BICA EXTRAÍVEL U" COM 2 FUNÇÕES PRÁTICA</p> <p>CROMADO</p>  |



**KITCHEN CELITE**

| IMAGEM  | CÓDIGO            | DESCRIÇÃO  |
|---|-------------------|--|
|  | <p>B5000F1CR0</p> | <p>MONOCOMANDO PARA COZINHA DE MESA<br/>BICA EXTRAÍVEL COM 2 FUNÇÕES KITCHEN<br/>CROMADO</p> |



**NORONHA**



| IMAGEM  | CÓDIGO     | DESCRIÇÃO  |
|---|------------|--|
|    | B5003CUCR0 | MONOCOMANDO PARA LAVATORIO DE MESA<br>BICA ALTA NORONHA                          |
|   |            | CROMADO  |
|    | B5002CUCR0 | MONOCOMANDO PARA LAVATORIO DE MESA<br>BICA BAIXA NORONHA                         |
|   |            | CROMADO  |
|   | B5001CUCR0 | TORNEIRA PARA LAVATORIO DE MESA BICA<br>ALTA NORONHA                             |
|   |            | CROMADO  |
|  | B5000CUCR0 | TORNEIRA PARA LAVATORIO DE MESA BICA<br>BAIXA NORONHA                            |
|   |            | CROMADO  |
|  | B5004CUCR0 | ACABAMENTO PARA MONOCOMANDO DE<br>BANHEIRA E CHUVEIRO NORONHA (COM<br>DESVIADOR) |
|   |            | CROMADO  |
|  | B5005CUCR0 | ACABAMENTO PARA MONOCOMANDO DE<br>BANHEIRA OU CHUVEIRO NORONHA                   |
|   |            | CROMADO  |

|   |                   |  |
|---|-------------------|--|
|   | <p>B5006CUCR0</p> | <p>BASE PARA MONOCOMANDO DE BANHEIRA E CHUVEIRO (COM DESVIADOR)</p> <p>CROMADO</p>               |
|  | <p>B5007CUCR0</p> | <p>BASE PARA MONOCOMANDO DE BANHEIRA OU CHUVEIRO</p> <p>CROMADO</p>                              |
|  | <p>B5008CUCR0</p> | <p>MONOCOMANDO PARA COZINHA DE MESA BICA ALTA COM AREJADOR ARTICULADO NORONHA</p> <p>CROMADO</p> |

RIVIERA

| IMAGEM  | CÓDIGO     | DESCRIÇÃO   |
|---|------------|---|
|    | B5003CTCR0 | MONOCOMANDO PARA LAVATORIO DE MESA<br>BICA ALTA RIVIERA         |
|   |            | CROMADO   |
|    | B5002CTCR0 | MONOCOMANDO PARA LAVATORIO DE MESA<br>BICA BAIXA RIVIERA        |
|   |            | CROMADO   |
|   | B5001CTCR0 | TORNEIRA PARA LAVATORIO DE MESA BICA<br>ALTA RIVIERA            |
|   |            | CROMADO   |
|  | B5000CTCR0 | TORNEIRA PARA LAVATORIO DE MESA BICA<br>BAIXA RIVIERA           |
|   |            | CROMADO   |
|  | B5006CUCR0 | BASE PARA MONOCOMANDO DE BANHEIRA E<br>CHUVEIRO (COM DESVIADOR) |
|   |            | CROMADO   |
|  | B5007CUCR0 | BASE PARA MONOCOMANDO DE BANHEIRA OU<br>CHUVEIRO                |
|   |            | CROMADO   |



|   |                   |  |
|---|-------------------|--|
|   | <p>B5004CTCR0</p> | <p>ACABAMENTO PARA MONOCOMANDO DE BANHEIRA E CHUVEIRO RIVIERA (COM DESVIADOR)</p> <p>CROMADO</p> |
|  | <p>B5005CTCR0</p> | <p>ACABAMENTO PARA MONOCOMANDO DE BANHEIRA OU CHUVEIRO RIVIERA</p> <p>CROMADO</p>                |
|  | <p>B5008CTCR0</p> | <p>MONOCOMANDO PARA COZINHA DE MESA BICA ALTA COM AREJADOR ARTICULADO RIVIERA</p> <p>CROMADO</p> |

**ECOLINE**

| IMAGEM  | CÓDIGO     | DESCRIÇÃO   |
|---|------------|---|
|    | B5003CDCR0 | MONOCOMANDO PARA LAVATORIO DE MESA<br>BICA ALTA ECOLINE<br>CROMADO                          |
|    | B5000CDCR0 | MONOCOMANDO PARA LAVATORIO DE MESA<br>BICA BAIXA ECOLINE<br>CROMADO                         |
|   | B5004CDCR0 | MONOCOMANDO PARA BIDÊ SEM DUCHA<br>ECOLINE<br>CROMADO                                       |
|  | B5005CDCR0 | MONOCOMANDO BANHEIRA E CHUVEIRO<br>ECOLINE (COM DESVIADOR)<br>CROMADO                       |
|  | B5006CDCR0 | MONOCOMANDO DE BANHEIRA OU CHUVEIRO<br>ECOLINE<br>CROMADO                                   |
|  | B5002CDCR0 | MONOCOMANDO PARA COZINHA DE MESA<br>BICA ALTA COM AREJADOR ARTICULADO<br>ECOLINE<br>CROMADO |



B5001CDCR0

MONOCOMANDO PARA COZINHA DE MESA  
BICA BAIXA COM AREJADOR ARTICULADO  
ECOLINE

CROMADO

**CHUVEIROS CELITE**

| IMAGEM  | CÓDIGO            | DESCRIÇÃO  |
|---|-------------------|--|
|    | <p>B5846C6CRB</p> | <p>CHUVEIRO COM BRAÇO DE PAREDE REDONDA<br/>70 MM GANGES</p> <p>CROMADO<br/>Caixa master: 2</p>  |
|    | <p>B5847C6CRB</p> | <p>CHUVEIRO COM BRAÇO DE PAREDE REDONDA<br/>90 MM VOLGA</p> <p>CROMADO<br/>Caixa master: 2</p>   |
|  | <p>B5008C8CRB</p> | <p>CHUVEIRO COM BRAÇO DE PAREDE<br/>QUADRADO 220 MM ELITE</p> <p>CROMADO<br/>Caixa master: 2</p> |
|  | <p>B5001C1CRB</p> | <p>CHUVEIRO COM BRAÇO DE PAREDE<br/>REDONDO 220 MM LIFE</p> <p>CROMADO<br/>Caixa master: 2</p>   |
|  | <p>B5013CMCRB</p> | <p>CHUVEIRO COM BRAÇO DE PAREDE<br/>REDONDO 80 MM SMART</p> <p>CROMADO<br/>Caixa master: 2</p>   |
|  | <p>B5015CMCRB</p> | <p>CHUVEIRO 80MM COM DESVIADOR COM<br/>DUCHA MANUAL SMART</p> <p>CROMADO<br/>Caixa master: 2</p> |











DUCHA MANUAL 80 MM COM DESVIADOR  
SMART

B5014CMCRB

CROMADO  
Caixa master: 2

**COMPLEMENTOS CELITE**

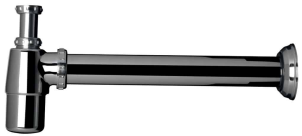
| IMAGEM   | CÓDIGO     | DESCRIÇÃO   |
|--|------------|---|
|    | B5008R0CR3 | FLEXIVEL DE ALIMENTAÇÃO 400 MM DE AÇO INOX TRANÇADO COM CANOPLA<br><br>CROMADO<br>Caixa master: 6 |
|   | B5007R0CR3 | FLEXIVEL 300 MM AÇO INOX TRANÇADO COM CANOPLA<br><br>CROMADO<br>Caixa master: 48                  |
|  | B5007C5013 | SIFÃO AJUSTÁVEL 7/8", 1.1/4", 1.1/2" X DN38, D40, DN48, DN50<br><br>BRANCO                        |
|  | B5008C5013 | TUBO AJUSTÁVEL 7/8", 1.1/4", 1.1/2" X DN38, D40, DN48, DN50<br><br>BRANCO                         |
|              | B5002R0CRB | SIFÃO PARA COZINHA 1.1/2" X DN40 X 300 MM COM ADAPTADOR DN50<br><br>CROMADO<br>Caixa master: 4    |
|    | B5000R0CRB | SIFÃO PARA LAVATÓRIO 7/8" X DN40 X 300 MM<br><br>CROMADO<br>Caixa master: 4                       |

|   |                   |   |
|---|-------------------|---|
|     | <p>B5001R0CRB</p> | <p>SIFÃO PARA TANQUE 1.1/4" X DN40 X 200 MM<br/>COM ADAPTADOR DN50</p> <p>CROMADO<br/>Caixa master: 4</p>           |
|    | <p>A5013C5CR2</p> | <p>SIFÃO PARA COZINHA 1.1/2" DN40 X 40 C/ADAP<br/>TE20</p> <p>CROMADO</p>   |
|    | <p>A5003C5CR2</p> | <p>SIFÃO PARA LAVATORIO 7/8" X DN40 X 40 TE20</p> <p>CROMADO</p>  |
|  | <p>A5009C5CR2</p> | <p>SIFÃO PARA TANQUE 1.1/4" X DN40 X 40<br/>C/ADAP TE20</p> <p>CROMADO</p>  |
|  | <p>B5830C5CRB</p> | <p>VÁLVULA DE ESCOAMENTO PARA COZINHA<br/>3.1/2" X 1.1/2" COM CESTA DE METAL</p> <p>CROMADO<br/>Caixa master: 4</p> |
|  | <p>B5831C5CRB</p> | <p>VÁLVULA DE ESCOAMENTO PARA COZINHA<br/>4.1/2" X 1.1/2" COM CESTA DE METAL</p> <p>CROMADO<br/>Caixa master: 2</p> |



B5828C5CR3

VÁLVULA DE ESCOAMENTO PARA LAVATORIO  
7/8" SEM LADRÃO COM TAMPA PLÁSTICA

CROMADO  
Caixa master: 6



B5026C5CR3

VÁLVULA DE ESCOAMENTO PARA LAVATÓRIO  
7/8" UNIVERSAL COM TAMPA PLÁSTICA

CROMADO



B5829C5CR3

VÁLVULA DE ESCOAMENTO PARA TANQUE  
1.1/4" SEM LADRÃO COM TAMPA PLÁSTICA

CROMADO  
Caixa master: 6







**INSTITUCIONAL**

| IMAGEM  | CÓDIGO     | DESCRIÇÃO   |
|---|------------|---|
|       | B5002CHCR0 | <p>PORTA-TOALHAS INSTITUCIONAL</p> <p>CROMADO</p>                   |
|       | B5004CHCR0 | <p>SABONETEIRA DE CANTO INSTITUCIONAL</p> <p>CROMADO</p>            |
|   | B5005CHCR0 | <p>SABONETEIRA DUPLA INSTITUCIONAL</p> <p>CROMADO</p>               |
|   | B5003CHCR0 | <p>SABONETEIRA INSTITUCIONAL</p> <p>CROMADO</p>                     |
|   | B5000CHCR0 | <p>DISPENSER PARA SABONETE LIQUIDO INSTITUCIONAL</p> <p>CROMADO</p> |
|   | B5001CHCR0 | <p>PORTA-ESCOVA HIGIÊNICA INSTITUCIONAL</p> <p>CROMADO</p>          |



**ACESSO CELITE**







| IMAGEM  | CÓDIGO     | DESCRIÇÃO   |
|---|------------|---|
|    | B5004CXCR0 | BARRA DE APOIO EM L" 700 MM ACESSO CELITE (CONFORME NORMA ABNT NBR 9050)<br><br>CROMADO |
|    | B5000CXCR0 | BARRA DE APOIO 300 MM ACESSO CELITE<br><br>CROMADO                                      |
|  | B5001CXCR0 | BARRA DE APOIO 450 MM ACESSO CELITE (CONFORME NORMA ABNT NBR 9050)<br><br>CROMADO       |
|  | B5002CXCR0 | BARRA DE APOIO 600 MM ACESSO CELITE (CONFORME NORMA ABNT NBR 9050)<br><br>CROMADO       |
|  | B5003CXCR0 | BARRA DE APOIO 800 MM ACESSO CELITE (CONFORME NORMA ABNT NBR 9050)<br><br>CROMADO       |



**Processada em: 01/03/2021 07:57:53**

**Processada em: 01/03/2021 07:57:53**







# MÓ \_V E I S

**CUBE**

| IMAGEM  | CÓDIGO            | DESCRIÇÃO  |
|---|-------------------|--|
|    | <p>B60001M020</p> | <p>GABINETE INTEGRADO 2 GAVETAS 65X43<br/>CUBE COM LAVATÓRIO</p> <p>WENGE</p>              |
|    | <p>B60002M020</p> | <p>GABINETE INTEGRADO 2 GAVETAS 65X43<br/>CUBE COM LAVATÓRIO</p> <p>CARVALHO</p>           |
|   | <p>B60017M020</p> | <p>GABINETE INTEGRADO 2 GAVETAS 55X43<br/>CUBE COM LAVATÓRIO</p> <p>Wengue/Branco</p>      |
|  | <p>B60022M020</p> | <p>GABINETE INTEGRADO COM 2 PORTAS 60X34<br/>CUBE COM LAVATÓRIO</p> <p>Carvalho/Branco</p> |
|  | <p>B60020M020</p> | <p>GABINETE INTEGRADO 2 GAVETAS 45X43<br/>CUBE COM LAVATÓRIO</p> <p>Carvalho/Branco</p>    |
|  | <p>B60018M020</p> | <p>GABINETE INTEGRADO 2 GAVETAS 55X43<br/>CUBE COM LAVATÓRIO</p> <p>Carvalho/Branco</p>    |

|   |                   |   |
|---|-------------------|---|
|   |                   | <p>GABINETE INTEGRADO COM 2 PORTAS 60X34<br/>CUBE COM LAVATÓRIO</p> |
|   | <p>B60009M020</p> | <p>BRANCO BRILHANTE</p>   |
|  |                   | <p>GABINETE INTEGRADO 2 GAVETAS 65X43<br/>CUBE COM LAVATÓRIO</p>    |
|   | <p>B60000M020</p> | <p>BRANCO BRILHANTE</p>   |

**FIT**

| IMAGEM  | CÓDIGO            | DESCRIÇÃO   |
|---|-------------------|---|
|    | <p>B60000M270</p> | <p>KIT GABINETE FIT COM 3 GAVETAS E 1 PORTA 60X38 COM CUBA DE APOIO</p> <p>BRANCO</p>     |
|    | <p>B60004M270</p> | <p>KIT GABINETE FIT 3 GAVETAS E 2 PORTAS 80X38 COM CUBA DE APOIO</p> <p>BRANCO</p>        |
|   | <p>B60001M270</p> | <p>KIT GABINETE FIT COM 3 GAVETAS E 1 PORTA 60X38 E CUBA DE APOIO</p> <p>WENGE</p>        |
|  | <p>B60005M270</p> | <p>KIT GABINETE FIT 3 GAVETAS E 2 PORTAS 80X38 COM CUBA DE APOIO</p> <p>WENGE</p>         |
|  | <p>B60003M270</p> | <p>KIT GABINETE FIT 3 GAVETAS E 1 PORTA 60X38 COM CUBA DE APOIO</p> <p>Wengue/Branco</p>  |
|  | <p>B60007M270</p> | <p>KIT GABINETE FIT 3 GAVETAS E 2 PORTAS 80X38 COM CUBA DE APOIO</p> <p>Wengue/Branco</p> |





KIT GABINETE FIT COM 3 GAVETAS E 1 PORTA  
60X38 COM CUBA DE APOIO

B60002M270

Branco/Wengue





KIT GABINETE FIT 3 GAVETAS E 2 PORTAS  
80X38 COM CUBA DE APOIO

B60006M270

Branco/Wengue

**BASIC**

| IMAGEM  | CÓDIGO            | DESCRIÇÃO   |
|---|-------------------|---|
|    | <p>B60057M090</p> | <p>KIT GABINETE BASIC COM GAVETA E PORTA 50X38 COM CUBA R1</p> <p>BRANCO</p>          |
|    | <p>B60065M090</p> | <p>KIT GABINETE BASIC COM GAVETA E PORTA 60X38 COM CUBA DE APOIO Q6</p> <p>BRANCO</p> |
|   | <p>B60061M090</p> | <p>KIT GABINETE BASIC COM GAVETA E PORTA 60X38 COM CUBA DE APOIO R1</p> <p>BRANCO</p> |
|  | <p>B60069M090</p> | <p>KIT GABINETE BASIC COM GAVETA E PORTA 80X38 COM CUBA Q6</p> <p>BRANCO</p>          |
|  | <p>B60053M090</p> | <p>KIT GABINETE BASIC COM 2 PORTAS 50X38 COM CUBA R1</p> <p>BRANCO</p>                |
|  | <p>B60058M090</p> | <p>KIT GABINETE BASIC COM GAVETA E PORTA 50X38 COM CUBA R1</p> <p>WENGE</p>           |

|   |                   |  |
|---|-------------------|--|
|     | <p>B60066M090</p> | <p>KIT GABINETE BASIC COM GAVETA E PORTA<br/>60X38 COM CUBA DE APOIO Q6</p> <p>WENGE</p>     |
|    | <p>B60062M090</p> | <p>KIT GABINETE BASIC COM GAVETA E PORTA<br/>60X38 COM CUBA DE APOIO R1</p> <p>WENGE</p>     |
|    | <p>B60070M090</p> | <p>KIT GABINETE BASIC COM GAVETA E PORTA<br/>80X38 COM CUBA Q6</p> <p>WENGE</p>              |
|   | <p>B60054M090</p> | <p>KIT GABINETE 2 PORTAS 50X38 COM CUBA R1<br/>BASIC</p> <p>WENGE</p>                        |
|  | <p>B60068M090</p> | <p>GABINETE BASIC COM GAVETA E PORTA 60X38<br/>COM CUBA DE APOIO Q6</p> <p>Wengue/Branco</p> |
|  | <p>B60060M090</p> | <p>KIT GABINETE BASIC COM GAVETA E PORTA<br/>50X38 COM CUBA R1</p> <p>Wengue/Branco</p>      |







|   |                   |  |
|---|-------------------|--|
|   | <p>B60064M090</p> | <p>KIT GABINETE BASIC COM GAVETA E PORTA<br/>60X38 COM CUBA DE APOIO R1</p> <p>Wengue/Branco</p> |
|  | <p>B60056M090</p> | <p>KIT GABINETE BASIC COM 2 PORTAS 50X38<br/>COM CUBA R1</p> <p>Wengue/Branco</p>                |
|  | <p>B60072M090</p> | <p>KIT GABINETE GAVETA E PORTA 80X38 COM<br/>CUBA Q6 BASIC</p> <p>Wengue/Branco</p>              |





NET

| IMAGEM  | CÓDIGO     | DESCRIÇÃO  |
|---|------------|--|
|    |            | KIT GABINETE COM 2 PORTAS 50X36<br>LAVATÓRIO INTEGRADO E ESPELHO NET                   |
|   | B60003M300 | BRANCO   |
|    |            | KIT GABINETE NET COM 3 GAVETAS E 1 PORTA<br>50X36 COM LAVATÓRIO INTEGRADO E<br>ESPELHO |
|   | B60000M300 | BRANCO   |
|   |            | KIT GABINETE COM 3 GAVETAS E 1 PORTA<br>50X36 LAVATÓRIO INTEGRADO E ESPELHO<br>NET     |
|   | B60002M300 | WENGE  |
|  |            | KIT GABINETE NET COM 2 PORTAS 50X36,<br>LAVATÓRIO INTEGRADO E ESPELHO                  |
|   | B60005M300 | WENGE  |
|  |            | KIT GABINETE COM 2 PORTAS 50X36<br>LAVATÓRIO INTEGRADO E ESPELHO NET                   |
|   | B60004M300 | Branco/Wengue  |
|  |            | KIT GABINETE COM 3 GAVETAS E 1 PORTA<br>50X36 LAVATÓRIO INTEGRADO E ESPELHO NET        |
|   | B60001M300 | Branco/Wengue  |







LIKE



| IMAGEM  | CÓDIGO     | DESCRIÇÃO   |
|---|------------|---|
|    | B60016M210 | KIT LIKE GABINETE COM 2 PORTAS E 1 GAVETA 60X34 COM LAVATÓRIO INTEGRADO, ESPELHO, PRATELEIRA E MÓDULO |
|   |            | BRANCO  |
|    | B60019M210 | KIT LIKE GABINETE 1 PORTA E 3 GAVETAS 60X34 COM LAVATÓRIO INTEGRADO, ESPELHO, PRATELEIRA E MÓDULO     |
|   |            | BRANCO  |
|   | B60002M210 | KIT GABINETE COM 1 PORTA 41X34 ESPELHO E PRATELEIRA LIKE  |
|   |            | WENGE   |
|  | B60005M210 | KIT GABINETE LIKE 1 PORTA E 1 GAVETA 41X34 COM ESPELHO  |
|   |            | WENGE   |
|  | B60018M210 | KIT LIKE GABINETE COM 2 PORTAS E 1 GAVETA 60X34 COM LAVATÓRIO INTEGRADO, ESPELHO, PRATELEIRA E MÓDULO |
|   |            | WENGE   |
|  | B60021M210 | KIT LIKE GABINETE 1 PORTA E 3 GAVETAS 60X34, LAVATÓRIO INTEGRADO, ESPELHO, PRATELEIRA E MÓDULO        |
|   |            | WENGE   |

|   |                   |  |
|---|-------------------|--|
|     |                   | <p>KIT GABINETE LIKE 1 PORTA E 1 GAVETA 41X34 COM ESPELHO</p>  |
|   | <p>B60009M210</p> | <p>CARVALHO</p>  |
|    |                   | <p>KIT GABINETE LIKE 1 PORTA 41X34 COM ESPELHO E PRATELEIRA</p>  |
|   | <p>B60007M210</p> | <p>CARVALHO</p>  |
|  |                   | <p>KIT GABINETE LIKE 1 PORTA E 1 GAVETA 41X34 COM ESPELHO</p>  |
|   | <p>B60004M210</p> | <p>Wengue/Branco</p>   |
|  |                   | <p>KIT GABINETE LIKE 1 PORTA 41X34 COM ESPELHO E PRATELEIRA</p>  |
|   | <p>B60001M210</p> | <p>Wengue/Branco</p>   |
|  |                   | <p>KIT LIKE GABINETE COM 2 PORTAS E 1 GAVETA 60X34 COM LAVATÓRIO INTEGRADO, ESPELHO, PRATELEIRA E MÓDULO</p> |
|   | <p>B60017M210</p> | <p>Wengue/Branco</p>   |
|  |                   | <p>KIT LIKE GABINETE 1 PORTA E 3 GAVETAS 60X34, LAVATÓRIO INTEGRADO, ESPELHO, PRATELEIRA E MÓDULO</p>        |
|   | <p>B60020M210</p> | <p>Wengue/Branco</p>   |



|   |                   |  |
|---|-------------------|--|
|     |                   | <p>KIT GABINETE LIKE 1 PORTA E 1 GAVETA 41X34<br/>COM ESPELHO</p>    |
|   | <p>B60008M210</p> | <p>Carvalho/Branco</p>   |
|    |                   | <p>KIT GABINETE LIKE 1 PORTA 41X34 COM<br/>ESPELHO E PRATELEIRA</p>  |
|   | <p>B60006M210</p> | <p>Carvalho/Branco</p>   |
|  |                   | <p>KIT GABINETE LIKE COM 1 PORTA 41X34,<br/>ESPELHO E PRATELEIRA</p> |
|   | <p>B60000M210</p> | <p>BRANCO BRILHANTE</p>  |
|  |                   | <p>KIT GABINETE LIKE 1 PORTA E 1 GAVETA 41X34<br/>COM ESPELHO</p>    |
|   | <p>B60003M210</p> | <p>BRANCO BRILHANTE</p>  |

**SAVEIRO**

| IMAGEM  | CÓDIGO            | DESCRIÇÃO   |
|---|-------------------|---|
|  | <p>B60000M260</p> | <p>KIT GABINETE SAVEIRO 2 PORTAS 40X22 COM LAVATÓRIO INTEGRADO E ESPELHO</p> <p>BRANCO</p>        |
|  | <p>B60001M260</p> | <p>KIT GABINETE SAVEIRO 2 PORTAS 40X22 COM LAVATÓRIO INTEGRADO E ESPELHO</p> <p>Branco/Wengue</p> |









**GABINETE PARA TANQUE**



| IMAGEM  | CÓDIGO     | DESCRIÇÃO                               |
|---|------------|---|
|  |            | KIT TANQUE COM GABINETE 75X38X39 CELITE |
|   | B60000M370 | BRANCO                                  |



# Celite

## MULTI

| IMAGEM   | CÓDIGO     | DESCRIÇÃO                          |
|--|------------|------------------------------------|
|   |            | ESPELHO COM BASE 54X58 MULTI       |
|  | B60005M080 | SILVER                             |
|   |            | ESPELHO COM BASE 65X58 MULTI PRATA |
|  | B60006M080 | SILVER                             |
|  |            | ESPELHO COM BASE 80X58 MULTI       |
|  | B60000M080 | SILVER                             |
|  |            | MODULO COLUNA 28X150 MULTI         |
|  | B60016M080 | WENGE                              |
|  |            | MODULO COLUNA 28X150 MULTI         |
|  | B60017M080 | CARVALHO                           |
|  |            | MODULO COLUNA 28X150 MULTI         |
|  | B60020M080 | Wengue/Branco                      |

|  |            |                            |
|--|------------|----------------------------|
|    |            | MODULO COLUNA 28X150 MULTI |
|  | B60021M080 | Carvalho/Branco            |
|  |            | MODULO COLUNA 28X150 MULTI |
|  | B60015M080 | BRANCO BRILHANTE           |

**Processada em: 01/03/2021 07:57:53**





**Processada em: 01/03/2021 07:57:53**

# BA NHEI \_ R A S

Celite





**BANHEIRA DUO COMFORT**

| IMAGEM   | CÓDIGO            | DESCRIÇÃO   |
|--|-------------------|---|
|    | <p>B2008BABR2</p> | <p>BANHEIRA AÇO 180X80 SEM VÁVULA E SEM ALÇA DUO COMFORT</p> <p>BRANCO</p>            |
|   | <p>B2010BA830</p> | <p>BANHEIRA AÇO 180X80 DUO COMFORT WOODLINE</p> <p>VERMELHO</p>                       |
|  | <p>B2009BA840</p> | <p>BANHEIRA AÇO 180X80 DUO COMFORT WOODLINE</p> <p>AZUL</p>                           |
|  | <p>C200000057</p> | <p>CONJUNTO NOVO BANHEIRA AÇO 180X80 COM VALVULA E ALÇA DUO COMFORT</p> <p>BRANCO</p> |









**BANHEIRA ATLANTICA**

| IMAGEM  | CÓDIGO     | DESCRIÇÃO  |
|---|------------|--|
|  |            | BANHEIRA AÇO 170X80 SEM VALVULA E SEM ALÇA ATLANTICA |
|   | B2000BTBR0 | BRANCO   |
|  |            | BANHEIRA AÇO 180X80 SEM VALVULA E SEM ALÇA ATLANTICA |
|   | B2001BTBR0 | BRANCO   |







**BANHEIRA EUROPA**





| IMAGEM  | CÓDIGO     | DESCRIÇÃO   |
|---|------------|---|
|    | B2012BACR0 | ALÇA FRESH (UMA) PARA BANHEIRA DUO COMFORT<br>CROMADO |
|    | B2013BACR0 | PAR DE ALÇAS FRESH PARA BANHEIRA<br>CROMADO           |
|  | B2005BABR2 | BANHEIRA AÇO 105X70 SEM VALVULA EUROPA<br>BRANCO      |
|   | B2006BABR2 | BANHEIRA AÇO 105X70 SEM VALVULA EUROPA MINI<br>BRANCO |
|  | B2004BABR2 | BANHEIRA AÇO 120X70 SEM VALVULA EUROPA<br>BRANCO      |
|   | B2015BABR0 | BANHEIRA AÇO 120X70 SEM VÁLVULA EUROPA MINI<br>BRANCO |

|   |                   |   |
|---|-------------------|---|
|    | <p>B2014BABR0</p> | <p>BANHEIRA AÇO 130X70 SEM VALVULA EUROPA</p> <p>BRANCO</p>               |
|    | <p>B2003BABR2</p> | <p>BANHEIRA AÇO 140X70 SEM VALVULA EUROPA</p> <p>BRANCO</p>               |
|    | <p>B2002BABR2</p> | <p>BANHEIRA AÇO 150X70 SEM VÁLVULA EUROPA</p> <p>BRANCO</p>               |
|  | <p>B2001BABR2</p> | <p>BANHEIRA AÇO 160X70 SEM VALVULA EUROPA</p> <p>BRANCO</p>               |
|  | <p>B2000BABR2</p> | <p>BANHEIRA AÇO 170X70 SEM VALVULA EUROPA</p> <p>BRANCO</p>               |
|   | <p>C200000045</p> | <p>CONJUNTO NOVO BANHEIRA AÇO 105X70 COM VALVULA EUROPA</p> <p>BRANCO</p> |

|  |            |  |
|--|------------|--|
|      |            | <p>CONJUNTO NOVO BANHEIRA AÇO 105X70 COM VALVULA EUROPA MINI</p> |
|  | C200000043 | BRANCO   |
|    |            | <p>CONJUNTO NOVO BANHEIRA AÇO 120X70 COM VALVULA EUROPA</p>      |
|  | C200000046 | BRANCO   |
|  |            | <p>CONJUNTO NOVO BANHEIRA AÇO 120X70 COM VALVULA EUROPA MINI</p> |
|  | C200000044 | BRANCO   |
|  |            | <p>CONJUNTO NOVO BANHEIRA AÇO 130X70 COM VALVULA EUROPA</p>      |
|  | C200000047 | BRANCO   |
|  |            | <p>CONJUNTO NOVO BANHEIRA AÇO 140X70 COM VALVULA EUROPA</p>      |
|  | C200000048 | BRANCO   |
|  |            | <p>CONJUNTO NOVO BANHEIRA AÇO 150X70 COM VALVULA EUROPA</p>      |
|  | C200000049 | BRANCO   |

|  |            |  |
|--|------------|--|
|      |            | <p>CONJUNTO NOVO BANHEIRA AÇO 160X70 COM VALVULA EUROPA</p>        |
|  | C200000050 | BRANCO   |
|    |            | <p>CONJUNTO NOVO BANHEIRA AÇO 170X70 COM VALVULA EUROPA</p>        |
|  | C200000051 | BRANCO   |
|  |            | <p>PALETE NOVO COM 22 BANHEIRA 105X70 EUROPA MINI COM VALVULA</p>  |
|  | C200000034 | BRANCO   |
|  |            | <p>PALETE NOVO COM 22 BANHEIRA 120X70 EUROPA MINI COM VALVULA</p>  |
|  | C200000035 | BRANCO   |
|  |            | <p>PALETE NOVO COM 24 PEÇAS BANHEIRA 105X70 EUROPA COM VALVULA</p> |
|  | C200000036 | BRANCO   |
|  |            | <p>PALETE NOVO COM 24 PEÇAS BANHEIRA 130X70 EUROPA COM VALVULA</p> |
|  | C200000038 | BRANCO   |



|  |            |  |
|--|------------|--|
|      |            | <p>PALETE NOVO COM 24 PEÇAS BANHEIRA<br/>140X70 EUROPA COM VALVULA</p> |
|  | C200000039 | BRANCO   |
|    |            | <p>PALETE NOVO COM 24 PEÇAS BANHEIRA<br/>150X70 EUROPA COM VALVULA</p> |
|  | C200000040 | BRANCO   |
|  |            | <p>PALETE NOVO COM 24 PEÇAS BANHEIRA<br/>170X70 EUROPA COM VALVULA</p> |
|  | C200000042 | BRANCO   |
|  |            | <p>PALETE NOVO COM 24 PEÇAS BANHEIRO<br/>120X70 EUROPA COM VALVULA</p> |
|  | C200000037 | BRANCO   |
|  |            | <p>PALETE NOVO COM 24 PEÇAS BANHEIRO<br/>160X70 EUROPA COM VALVULA</p> |
|  | C200000041 | BRANCO   |

**SUPERSLIM**

| IMAGEM  | CÓDIGO  | DESCRIÇÃO  |
|---|---|--|
|    | B2006P2BR0  | PISO BOX DE AÇO 120X75X3 COM VÁLVULA SUPERSLIM<br>BRANCO |
|   |    | B2005P2BR0   |
|   |   | B2004P2BR0   |
|   |  | B2003P2BR0   |
|  |   | B2002P2BR0   |
|   |  | B2001P2BR0   |



UNIVERSAL

| IMAGEM  | CÓDIGO     | DESCRIÇÃO   |
|---|------------|---|
|    |            | PISO BOX DE AÇO 100X100X2,5 SEM VÁLVULA UNIVERSAL |
|   | B200390BR0 | BRANCO  |
|    |            | PISO BOX DE AÇO 100X100X6,5 SEM VÁLVULA UNIVERSAL |
|   | B200490BR0 | BRANCO  |
|   |            | PISO BOX DE AÇO 100X80X2,5 SEM VÁLVULA UNIVERSAL  |
|   | B200990BR0 | BRANCO  |
|  |            | PISO BOX DE AÇO 100X80X6,5 SEM VÁLVULA UNIVERSAL  |
|   | B201090BR0 | BRANCO  |
|  |            | PISO BOX DE AÇO 120X80X2,5 SEM VÁLVULA UNIVERSAL  |
|   | B200590BR0 | BRANCO  |
|  |            | PISO BOX DE AÇO 120X80X6,5 SEM VÁLVULA UNIVERSAL  |
|   | B200690BR0 | BRANCO  |

|   |            |  |
|---|------------|--|
|     |            | PISO BOX DE AÇO 130X80X2,5 SEM VÁLVULA UNIVERSAL |
|   | B2002P1BR0 | BRANCO   |
|    |            | PISO BOX DE AÇO 130X80X6,5 SEM VÁLVULA UNIVERSAL |
|   | B2001P1BR0 | BRANCO   |
|    |            | PISO BOX DE AÇO 140X80X2,5 SEM VÁLVULA UNIVERSAL |
|   | B200790BR0 | BRANCO   |
|  |            | PISO BOX DE AÇO 140X80X6,5 SEM VÁLVULA UNIVERSAL |
|   | B200890BR0 | BRANCO   |
|  |            | PISO BOX DE AÇO 90X75X2,5 SEM VÁLVULA UNIVERSAL  |
|   | B2004P1BR2 | BRANCO   |
|  |            | PISO BOX DE AÇO 90X75X6,5 SEM VÁLVULA UNIVERSAL  |
|   | B2005P1BR2 | BRANCO   |



B2006P1CR3

VALVULA DE ESCOAMENTO PISO BOX  
UNIVERSAL 90MM SAÍDA HORIZONTAL

CROMADO



B2003P1CR0

VALVULA DE ESCOAMENTO PISO BOX  
UNIVERSAL 90MM SAÍDA VERTICAL

CROMADO

**EUROPA STD**

| IMAGEM  | CÓDIGO     | DESCRIÇÃO                                   |
|---|------------|---|
|    |            | PISO BOX AÇO 80X80X14 SEM VÁLVULA EUROPA    |
|   | B2001P3BR0 | BRANCO                                      |
|    |            | PISO BOX AÇO 90X90X7 SEM VÁLVULA EUROPA     |
|   | B2004P3BR0 | BRANCO                                      |
|   |            | PISO BOX DE AÇO 70X70X14 SEM VÁLVULA EUROPA |
|   | B2003P3BR0 | BRANCO                                      |
|  |            | PISO BOX DE AÇO 70X70X7 SEM VÁLVULA EUROPA  |
|   | B2006P3BR0 | BRANCO                                      |
|  |            | PISO BOX DE AÇO 80X80X7 SEM VÁLVULA EUROPA  |
|   | B2005P3BR0 | BRANCO                                      |
|  |            | PISO BOX DE AÇO 90X90X14 SEM VÁLVULA EUROPA |
|   | B2000P3BR0 | BRANCO                                      |



VALVULA DE ESCOAMENTO PISO BOX 52MM  
SAÍDA HORIZONTAL EUROPA

B2002P3CR0

CROMADO



VALVULA DE ESCOAMENTO PISO BOX 52MM  
SAÍDA VERTICAL EUROPA

B2007P3CR3

CROMADO



**BANHEIRA VALVULAS**

| IMAGEM   | CÓDIGO            | DESCRIÇÃO  |
|--|-------------------|--|
|    | <p>B2001BV003</p> | <p>VALVULA DE BANHEIRA PADRÃO INTERNACIONAL</p> <p>SEM COR</p>       |
|   | <p>B2006BVCR0</p> | <p>VALVULA ALIMENTACAO COM LADRAO BANHEIRA CELITE</p> <p>CROMADO</p> |
|  | <p>B2005BVCR0</p> | <p>VALVULA ESCOAMENTO PARA BANHEIRA CELITE</p> <p>CROMADO</p>        |

**Processada em: 01/03/2021 07:57:53**

**Processada em: 01/03/2021 07:57:53**

LO U  
Ç A S

Celite

DESIGN

| IMAGEM  | CÓDIGO        | DESCRIÇÃO  |
|---|---------------|--|
|    |               | CUBA DE APOIO QUADRADO COM MESA<br>350X350 DESIGN D3 |
|   | 1380670019300 | BRANCO   |
|   | 1380670109300 | NOITE  |
|   | 1380670149300 | BRANCO MATTE   |
|   | 1380670669300 | CASTANHA   |
|   | 1380670079300 | METRÓPOLE  |
|    |               | CUBA DE APOIO QUADRADO SEM MESA<br>380X380 DESIGN D2 |
|   | 1380610017300 | BRANCO   |
|   | 1380610667300 | CASTANHA   |
|   | 1380610147300 | BRANCO MATTE   |
|   | 1380610077300 | METRÓPOLE  |
|   | 1380610107300 | NOITE  |
|  |               | CUBA DE APOIO REDONDO SEM MESA 350<br>DESIGN D1      |
|   | 1380970017300 | BRANCO   |
|   | 1380970107300 | NOITE  |
|   | 1380970667300 | CASTANHA   |
|   | 1380970077300 | METRÓPOLE  |
|   | 1380970147300 | BRANCO MATTE   |







**BASIC**

| IMAGEM  | CÓDIGO               | DESCRIÇÃO   |
|---|----------------------|---|
|    | <p>1737250010300</p> | <p>KIT CUBA DE APOIO BASIC Q1, TORNEIRA BICA BAIXA BASIC E COMPLEMENTOS DE INSTALAÇÃO</p> <p>BRANCO</p> |
|    | <p>1737250012300</p> | <p>KIT CUBA DE APOIO BASIC R1, TORNEIRA BICA ALTA BASIC E COMPLEMENTOS DE INSTALAÇÃO</p> <p>BRANCO</p>  |
|   | <p>1737250011300</p> | <p>KIT CUBA Q6, TORNEIRA BICA BAIXA E COMPLEMENTOS DE INSTALAÇÃO BASIC</p> <p>BRANCO</p>                |
|  | <p>1560860011300</p> | <p>CUBA DE APOIO 510X390 FURO CENTRAL SEM LADRAO BASIC R5</p> <p>BRANCO</p>                             |
|  | <p>1730990017300</p> | <p>CUBA DE APOIO R0 300 CELITE</p> <p>BRANCO</p>  |



|   |               |  |
|---|---------------|--|
|    |               | CUBA DE APOIO 350 SEM MESA BASIC R1          |
|   | 1730970017300 | BRANCO                                       |
|   | 1730970027300 | PRETO  |
|   | 1730970667300 | CASTANHA                                     |
|   | 1730970147300 | BRANCO MATTE                                 |
|   | 1730970107300 | NOITE  |
|   | 1730970077300 | METRÓPOLE                                    |
| 1730970597300   | PERGAMON      |  |
|    |               | CUBA DE APOIO 350X350 COM MESA BASIC Q6      |
|   | 1730680013300 | BRANCO                                       |
|   | 1730680593300 | PERGAMON                                     |
|   | 1730680023300 | PRETO  |
|   | 1730680103300 | NOITE  |
|   | 1730680073300 | METRÓPOLE                                    |
|   | 1730680143300 | BRANCO MATTE                                 |
| 1730680663300   | CASTANHA      |  |
|   |               | CUBA DE APOIO 350X350 SEM MESA BASIC QR1     |
|   | 1730690017300 | BRANCO                                       |
|  |               | CUBA DE APOIO 350X350 SEM MESA BASIC Q5      |
|   | 1730490017300 | BRANCO                                       |
|   | 1730490027300 | PRETO  |
|   | 1730490597300 | PERGAMON                                     |
|   | 1730490107300 | NOITE  |
|   | 1730490147300 | BRANCO MATTE                                 |
|   | 1730490077300 | METRÓPOLE                                    |
| 1730490667300   | CASTANHA      |  |
|  |               | CUBA DE APOIO 370 DIAMETRO SEM MESA BASIC R2 |
|   | 1730980017300 | BRANCO                                       |

|   |               |  |
|---|---------------|--|
|     |               | CUBA DE APOIO 410X410 COM MESA BASIC Q1              |
|   | 1730670013300 | BRANCO   |
|   | 1730670663300 | CASTANHA   |
|   | 1730670143300 | BRANCO MATTE   |
|   | 1730670023300 | PRETO  |
|   | 1730670593300 | PERGAMON   |
|   | 1730670073300 | METRÓPOLE  |
|   | 1730670103300 | NOITE  |
|    |               | CUBA DE APOIO 42X42 VALVULA OCULTA COM MESA BASIC Q4 |
|   | 1730610013300 | BRANCO   |
|   | 1730610663300 | CASTANHA   |
|   | 1730610143300 | BRANCO MATTE   |
|   | 1730610073300 | METRÓPOLE  |
|   | 1730610103300 | NOITE  |
|   |               | CUBA DE APOIO 440X250 COM MESA BASIC CURVE 1         |
|   | 1730740013300 | BRANCO   |
|  |               | CUBA DE APOIO 440X410 COM MESA BASIC CURVE 2         |
|   | 1730730013300 | BRANCO   |
|  |               | CUBA DE APOIO 450X280 SEM MESA BASIC QR3             |
|   | 1730750017300 | BRANCO   |
|  |               | CUBA DE APOIO 450X300 SEM MESA BASIC R3              |
|   | 1730850017300 | BRANCO   |





|   |   |  |
|---|---|--|
|     | <p>1730280013300</p>  | <p>CUBA DE SEMIENCAIXE COM VÁLVULA OCULTA COM MESA BASIC CURVE 5</p> <p>BRANCO</p>   |
|    | <p>1730250013300</p> <p>1730250103300</p> <p>1730250663300</p> <p>1730250073300</p> <p>1730250143300</p> <p>1730250593300</p> | <p>CUBA DE SEMIENCAIXE 410X410 COM MESA BASIC Q2</p> <p>BRANCO</p> <p>NOITE</p> <p>CASTANHA</p> <p>METRÓPOLE</p> <p>BRANCO MATTE</p> <p>PERGAMON</p> |
|    | <p>1730500017300</p>  | <p>CUBA DE SOBREPOR/EMBUTIR 410X410 SEM MESA BASIC Q3</p> <p>BRANCO</p>  |
|  | <p>1731330011300</p>  | <p>CUBA DE SOBREPOR 420X420 COM MESA BASIC Q8</p> <p>BRANCO</p>  |
|  | <p>1730450013300</p>  | <p>CUBA DE SOBREPOR 410X340 COM MESA BASIC Q7</p> <p>BRANCO</p>  |

**ESSENCIAL**

| IMAGEM  | CÓDIGO               | DESCRIÇÃO  |
|---|----------------------|--|
|  | <p>1610680017300</p> | <p>CUBA DE APOIO 400X400 SEM MESA E SEM LADRÃO AR<br/>BRANCO</p>   |
|  | <p>1610770017300</p> | <p>CUBA DE APOIO 500X380 SEM MESA E SEM LADRAO AGUA<br/>BRANCO</p> |







**CLASSICA**

| IMAGEM  | CÓDIGO  | DESCRIÇÃO  |
|---|---|--|
|  | 1580040010300   | LAVATORIO PARA COLUNA 610X455 FURO CENTRAL COM LADRAO CLASSICA<br><br>BRANCO |
|   |  | 1582010010300  |



SMART

| IMAGEM  | CÓDIGO        | DESCRIÇÃO   |
|---|---------------|---|
|    | 1167230010300 | KIT BACIA COM CAIXA, ASSENTO PP SOFT CLOSE E COMPLEMENTOS DE INSTALAÇÃO SMART<br>BRANCO           |
|   | 1167230590300 | PERGAMON  |
|   | 1167230020300 | PRETO   |
|    | 1167270011300 | KIT BACIA CONVENCIONAL, ASSENTO PP SOFT CLOSE E COMPLEMENTOS DE INSTALAÇÃO SMART<br>BRANCO        |
|   | 1167270021300 | PRETO   |
|   | 1167270591300 | PERGAMON  |
|  | 1167270010300 | KIT BACIA CONVENCIONAL, ASSENTO TERMOFIXO SOFT CLOSE E COMPLEMENTOS DE INSTALAÇÃO SMART<br>BRANCO |
|   | 1167270140300 | BRANCO MATTE  |
|   | 1167270070300 | METRÓPOLE   |
|   | 1167270100300 | NOITE   |
|   | 1167270660300 | CASTANHA  |
|  | 1167230011300 | KIT BACIA COM CAIXA, ASSENTO TERMOFIXO SOFT CLOSE E COMPLEMENTOS DE INSTALAÇÃO SMART<br>BRANCO    |
|   | 1167230661300 | CASTANHA  |
|   | 1167230071300 | METRÓPOLE   |
|   | 1167230101300 | NOITE   |
|   | 1167230141300 | BRANCO MATTE  |
|  | 1167700011300 | CONJUNTO BACIA PARA CAIXA E CAIXA 3/6 LITROS SMART<br>BRANCO                                      |
|   | 1167700021300 | PRETO   |
|   | 1167700591300 | PERGAMON  |

|   |               |   |
|---|---------------|---|
|     |               | BACIA PARA CAIXA SMART                          |
|   | 1163510010300 | BRANCO  |
|   | 1163510100300 | NOITE   |
|   | 1163510140300 | BRANCO MATTE                                    |
|   | 1163510590300 | PERGAMON  |
|   | 1163510070300 | METRÓPOLE                                       |
|   | 1163510660300 | CASTANHA  |
| 1163510020300   | PRETO         |   |
|    |               | CAIXA ECOFLUSH 3/6 LITROS SMART                 |
|   | 1165600015300 | BRANCO  |
|   | 1165600595300 | PERGAMON  |
|   | 1165600665300 | CASTANHA  |
|   | 1165600025300 | PRETO   |
|   | 1165600145300 | BRANCO MATTE                                    |
|   | 1165600075300 | METRÓPOLE                                       |
| 1165600105300   | NOITE         |   |
|   |               | BACIA CONVENCIONAL SMART                        |
|   | 1163010010300 | BRANCO  |
|   | 1163010020300 | PRETO   |
|   | 1163010660300 | CASTANHA  |
|   | 1163010590300 | PERGAMON  |
|   | 1163010070300 | METRÓPOLE                                       |
|   | 1163010100300 | NOITE   |
| 1163010140300   | BRANCO MATTE  |   |
|  |               | BIDE 3 FUROS COM DUCHA COM LADRAO RIVIERA/SMART |
|   | 1124000010300 | BRANCO  |
| 1124000590300   | PERGAMON      |   |
|  |               | CUBA DE APOIO 400X355 COM MESA SMART            |
|   | 1160850013300 | BRANCO  |
|  |               | ASSENTO ORIGINAL POLIPROPILENO RIVIERA/SMART    |
|   | 3129810010100 | BRANCO  |

|   |                      |  |
|---|----------------------|--|
|     | <p>3129880010300</p> | <p>ASSENTO ORIGINAL SOFT CLOSE<br/>RIVIERA/SMART</p> <p>BRANCO</p>           |
|    | <p>3169830010300</p> | <p>ASSENTO ORIGINAL TERMOFIXO SOFT CLOSE<br/>SMART</p> <p>BRANCO</p>         |
|    | <p>3129810020100</p> | <p>ASSENTO ORIGINAL POLIPROPILENO<br/>RIVIERA/SMART PRETO</p> <p>PRETO</p>   |
|  | <p>3129880020300</p> | <p>ASSENTO ORIGINAL SOFT CLOSE<br/>RIVIERA/SMART</p> <p>PRETO</p>            |
|  | <p>3169830070300</p> | <p>ASSENTO ORIGINAL TERMOFIXO SOFT CLOSE<br/>SMART/SLIM</p> <p>METRÓPOLE</p> |
|  | <p>3169830100300</p> | <p>ASSENTO ORIGINAL TERMOFIXO SOFT CLOSE<br/>SMART/SLIM</p> <p>NOITE</p>     |







|  |                      |  |
|--|----------------------|--|
|    | <p>3169830140300</p> | <p>ASSENTO ORIGINAL TERMOFIXO SOFT CLOSE<br/>SMART/SLIM</p> <p>BRANCO MATTE</p>  |
|   | <p>3129810590100</p> | <p>ASSENTO ORIGINAL POLIPROPILENO<br/>RIVIERA/SMART PERGAMON</p> <p>PERGAMON</p> |
|   | <p>3129880590300</p> | <p>ASSENTO ORIGINAL SOFT CLOSE<br/>RIVIERA/SMART</p> <p>PERGAMON</p>             |
|  | <p>3169830660300</p> | <p>ASSENTO ORIGINAL TERMOFIXO SOFT CLOSE<br/>SMART/SLIM</p> <p>CASTANHA</p>      |

ELITE

| IMAGEM  | CÓDIGO        | DESCRIÇÃO   |
|---|---------------|---|
|    |               | KIT BACIA COM CAIXA, ASSENTO PP SOFT CLOSE E COMPLEMENTOS DE INSTALAÇÃO ELITE   |
|   | 1747230010300 | BRANCO  |
|   | 1747230020300 | PRETO   |
|     |               | BACIA CONVENCIONAL COM COMPLEMENTOS DE INSTALAÇÕES, ASSENTO PP SOFT CLOSE ELITE |
|   | 1747270010300 | BRANCO  |
|   | 1747270020300 | PRETO   |
|     |               | CONJUNTO BACIA PARA CAIXA E CAIXA 3/6 LITROS ELITE                              |
|   | 1747700010300 | BRANCO  |
|   | 1747700020300 | PRETO   |
|  |               | BACIA PARA CAIXA ELITE  |
|   | 1743530010300 | BRANCO  |
|   | 1743530020300 | PRETO   |
|  |               | CAIXA ECOFLUSH 3/6 LITROS ACIONAMENTO ELITE                                     |
|   | 1745700015300 | BRANCO  |
|   | 1745700025300 | PRETO   |
|  |               | BACIA CONVENCIONAL ELITE  |
|   | 1743030010300 | BRANCO  |
|   | 1743030020300 | PRETO   |

|   |               |  |
|---|---------------|--|
|   |               | CUBA DE SOBREPOR 430X390 ELITE                     |
|   | 1741310011300 | BRANCO   |
|   | 1741310021300 | PRETO  |
|  |               | ASSENTO ORIGINAL POLIPROPILENO SOFT<br>CLOSE ELITE |
|   | 3749880010300 | BRANCO   |
|  |               | ASSENTO ORIGINAL POLIPROPILENO SOFT<br>CLOSE ELITE |
|   | 3749880020300 | PRETO  |

| IMAGEM  | CÓDIGO        | DESCRIÇÃO  |
|---|---------------|--|
|    | 1977230010300 | KIT BACIA RIMLESS COM CAIXA HARPIC,<br>ASSENTO PP SOFT CLOSE E COMPLEMENTOS<br>DE INSTALAÇÃO VIP<br>BRANCO |
|    | 1973650010300 | BACIA PARA CAIXA VIP<br>BRANCO   |
|   | 1555700015301 | CAIXA 3/6 LITROS HARPIC SMARTCLEAN<br>BRANCO   |
|   | 1555700017301 | CAIXA 3/6 LITROS TOUCHLESS HARPIC BR<br>BRANCO   |
|  | 9209880010300 | ASSENTO ORIGINAL POLIPROPILENO SOFT<br>CLOSE CITY/LIKE<br>BRANCO   |
|  | 9209880020300 | ASSENTO ORIGINAL POLIPROPILENO SOFT<br>CLOSE CITY/LIKE<br>PRETO  |

|  |               |  |
|--|---------------|--|
|   |               | ASSENTO ORIGINAL POLIPROPILENO SOFT<br>CLOSE CITY/LIKE |
|   | 9209880590300 | PERGAMON   |
|   |               | ASSENTO ORIGINAL POLIPROPILENO SOFT<br>CLOSE CITY/LIKE |
|  | 9209880770300 | CINZA PRATA  |

LIFE

| IMAGEM  | CÓDIGO        | DESCRIÇÃO   |
|---|---------------|---|
|     | 1987230010300 | KIT BACIA COM CAIXA, ASSENTO PP SOFT CLOSE E COMPLEMENTOS DE INSTALAÇÃO LIFE<br>BRANCO    |
|    | 1987270010300 | KIT BACIA CONVENCIONAL, ASSENTO PP SOFT CLOSE E COMPLEMENTOS DE INSTALAÇÃO LIFE<br>BRANCO |
|   | 1987710010300 | CONJUNTO BACIA PARA CAIXA E CAIXA 3/6 LITROS M LIFE<br>BRANCO                             |
|  | 1983510010300 | BACIA PARA CAIXA LIFE<br>BRANCO   |
|  | 1555600015300 | CAIXA M 3/6 LITROS CITY/RIVIERA/LIFE<br>BRANCO  |
|   | 1555600775300 | CINZA PRATA   |
|   | 1555600025300 | PRETO   |
|   | 1555600595300 | PERGAMON  |
|  | 1983010010300 | BACIA CONVENCIONAL LIFE<br>BRANCO   |

|   |               |  |
|---|---------------|--|
|    |               | CUBA DE APOIO 495X395 COM MESA LIFE                        |
|    | 1980850013300 | BRANCO   |
|    | 1980010011300 | LAVATÓRIO PARA COLUNA 485X395 FURO CENTRAL SEM LADRÃO LIFE |
|  | 1662010010300 | COLUNA PARA LAVATÓRIO FIT/LIFE                             |
|  | 1662010770300 | BRANCO   |
|  | 1662010020300 | CINZA PRATA  |
|   | 1662010290300 | PRETO  |
|   | 1662010590300 | AGUA MARINHA   |
|   | 1662010590300 | PERGAMON   |
|   |               | COLUNA SUSPensa PARA LAVATÓRIO FIT/LIFE                    |
|   | 1662020010300 | BRANCO   |
|   | 1662020590300 | PERGAMON   |
|   | 1662020020300 | PRETO  |
|   | 1662020770300 | CINZA PRATA  |
|   | 1662020290300 | AGUA MARINHA   |
|   |               | ASSENTO ORIGINAL POLIPROPILENO PLUS LIFE                   |
|   | 3989810010300 | BRANCO   |
|   |               | ASSENTO ORIGINAL POLIPROPILENO SOFT CLOSE LIFE             |
|   | 3989880010300 | BRANCO   |



ASSENTO ORIGINAL POLIPROPILENO SOFT  
CLOSE LIFE

3989880590300







PERGAMON







**FIT**

| IMAGEM  | CÓDIGO        | DESCRIÇÃO   |
|---|---------------|---|
|    |               | KIT BACIA COM CAIXA, ASSENTO PP SOFT CLOSE E COMPLEMENTOS DE INSTALAÇÃO FIT PLUS    |
|   | 1667230010300 | BRANCO  |
|   | 1667230590300 | PERGAMON  |
|   | 1667230770300 | CINZA PRATA   |
|   | 1667230290300 | AGUA MARINHA  |
| 1667230020300   | PRETO         |   |
|    |               | KIT BACIA CONVENCIONAL, ASSENTO PP SOFT CLOSE E COMPLEMENTOS DE INSTALAÇÃO FIT PLUS |
|   | 1667270010300 | BRANCO  |
|   | 1667270770300 | CINZA PRATA   |
|   | 1667270590300 | PERGAMON  |
|   | 1667270290300 | AGUA MARINHA  |
| 1667270020300   | PRETO         |   |
|  |               | KIT CUBA DE APOIO FIT, TORNEIRA BICA BAIXA BASIC E COMPLEMENTOS DE INSTALAÇÃO       |
|   | 1667250010300 | BRANCO  |
|  |               | CONJUNTO BACIA PARA CAIXA E CAIXA M 3/6 LITROS FIT PLUS                             |
|   | 1667730012300 | BRANCO  |
|   | 1667730772300 | CINZA PRATA   |
|   | 1667730022300 | PRETO   |
|   | 1667730592300 | PERGAMON  |
| 1667730292300   | AGUA MARINHA  |   |
|  |               | BACIA PARA CAIXA FIT PLUS   |
|   | 1663510010300 | BRANCO  |
|   | 1663510290300 | AGUA MARINHA  |
|   | 1663510020300 | PRETO   |
|   | 1663510770300 | CINZA PRATA   |
| 1663510590300   | PERGAMON      |   |

|   |               |   |
|---|---------------|---|
|     |               | CAIXA M PARA ACOPLAR 3/6 LITROS FIT PLUS                  |
|   | 1665600015300 | BRANCO  |
|   | 1665600775300 | CINZA PRATA   |
|   | 1665600025300 | PRETO   |
|   | 1665600595300 | PERGAMON  |
|   | 1665600295300 | AGUA MARINHA  |
|    |               | BACIA CONVENCIONAL FIT PLUS                               |
|   | 1663010010300 | BRANCO  |
|   | 1663010590300 | PERGAMON  |
|   | 1663010290300 | AGUA MARINHA  |
|   | 1663010770300 | CINZA PRATA   |
|   | 1663010020300 | PRETO   |
|    |               | BACIA CONVENCIONAL FIT                                    |
|   | 1663030020300 | PRETO   |
|  |               | CUBA DE APOIO RETANGULAR 450X370 COM MESA FIT             |
|   | 1660730013300 | BRANCO  |
|   | 1660730593300 | PERGAMON  |
|   | 1660730023300 | PRETO   |
|  |               | LAVATÓRIO PARA COLUNA 520X430 FURO CENTRAL SEM LADRAO FIT |
|   | 1660060011300 | BRANCO  |
|   | 1660060021300 | PRETO   |
|   | 1660060771300 | CINZA PRATA   |
|   | 1660060291300 | AGUA MARINHA  |
|   | 1660060591300 | PERGAMON  |
|  |               | COLUNA PARA LAVATÓRIO FIT/LIFE                            |
|   | 1662010010300 | BRANCO  |
|   | 1662010770300 | CINZA PRATA   |
|   | 1662010290300 | AGUA MARINHA  |
|   | 1662010020300 | PRETO   |
|   | 1662010590300 | PERGAMON  |

|   |               |   |
|---|---------------|---|
|     |               | COLUNA SUSPensa PARA LAVATÓRIO FIT/LIFE               |
|   | 1662020010300 | BRANCO  |
|   | 1662020020300 | PRETO   |
|   | 1662020590300 | PERGAMON  |
|   | 1662020290300 | AGUA MARINHA  |
|   | 1662020770300 | CINZA PRATA   |
|    |               | ASSENTO ORIGINAL FIT CONFORT                          |
|   | 3669840010300 | BRANCO  |
|    |               | ASSENTO ORIGINAL POLIPROPILENO FIT PLUS               |
|   | 9669810011300 | BRANCO  |
|  |               | ASSENTO ORIGINAL POLIPROPILENO FIT PLUS<br>SOFT CLOSE |
|   | 9669880010300 | BRANCO  |
|  |               | ASSENTO ORIGINAL TERMOFIXO SOFT CLOSE<br>FIT          |
|   | 3669830010300 | BRANCO  |
|  |               | ASSENTO ORIGINAL POLIPROPILENO FIT PLUS               |
|   | 9669810021300 | PRETO   |

|   |                      |   |
|---|----------------------|---|
|     | <p>9669880020300</p> | <p>ASSENTO ORIGINAL POLIPROPILENO FIT PLUS<br/>SOFT CLOSE</p> <p>PRETO</p>        |
|    | <p>9669810291300</p> | <p>ASSENTO ORIGINAL POLIPROPILENO FIT PLUS</p> <p>AGUA MARINHA</p>                |
|    | <p>9669880290300</p> | <p>ASSENTO ORIGINAL POLIPROPILENO FIT PLUS<br/>SOFT CLOSE</p> <p>AGUA MARINHA</p> |
|  | <p>9669810591300</p> | <p>ASSENTO ORIGINAL POLIPROPILENO FIT PLUS</p> <p>PERGAMON</p>                    |
|  | <p>9669880590300</p> | <p>ASSENTO ORIGINAL POLIPROPILENO FIT PLUS<br/>SOFT CLOSE</p> <p>PERGAMON</p>     |
|  | <p>9669810771300</p> | <p>ASSENTO ORIGINAL POLIPROPILENO FIT PLUS</p> <p>CINZA PRATA</p>                 |



ASSENTO ORIGINAL POLIPROPILENO FIT PLUS  
SOFT CLOSE





9669880770300

CINZA PRATA

CITY

| IMAGEM | CÓDIGO        | DESCRIÇÃO   |
|--------|---------------|---|
|        |               | KIT BACIA COM CAIXA P ASSENTO PP SOFT CLOSE E COMPLEMENTOS DE INSTALAÇÃO CITY   |
|        | 1207230012300 | BRANCO  |
|        | 1207230772300 | CINZA PRATA   |
|        | 1207230022300 | PRETO   |
|        | 1207230592300 | PERGAMON  |
|        |               | KIT BACIA CONVENCIONAL, ASSENTO PP SOFT CLOSE E COMPLEMENTOS DE INSTALAÇÃO CITY |
|        | 1207270010300 | BRANCO  |
|        | 1207270020300 | PRETO   |
|        | 1207270590300 | PERGAMON  |
|        | 1207270770300 | CINZA PRATA   |
|        |               | CONJUNTO BACIA PARA CAIXA E CAIXA 3/6 LITROS P CITY                             |
|        | 1207700012300 | BRANCO  |
|        | 1207700022300 | PRETO   |
|        | 1207700592300 | PERGAMON  |
|        | 1207700772300 | CINZA PRATA   |
|        |               | BACIA PARA CAIXA CITY PLUS  |
|        | 1203510010300 | BRANCO  |
|        | 1203510020300 | PRETO   |
|        | 1203510770300 | CINZA PRATA   |
|        | 1203510590300 | PERGAMON  |
|        |               | CAIXA 3/6 LITROS TOUCHLESS HARPIC BR  |
|        | 1555700017301 | BRANCO  |

|   |               |   |
|---|---------------|---|
|     |               | CAIXA PARA ACOPLAR 3/6 LITROS<br>LIKE/NET/CITY                |
|   | 1645600015300 | BRANCO  |
|   | 1645600775300 | CINZA PRATA   |
|   | 1645600025300 | PRETO   |
|   | 1645600595300 | PERGAMON  |
|    |               | BACIA CONVENCIONAL CITY PLUS                                  |
|   | 1203010010300 | BRANCO  |
|   | 1203010770300 | CINZA PRATA   |
|   | 1203010020300 | PRETO   |
|   | 1203010590300 | PERGAMON  |
|    |               | LAVATÓRIO PARA COLUNA 495X410 FURO<br>CENTRAL SEM LADRÃO CITY |
|   | 1200010011300 | BRANCO  |
|   | 1200010771300 | CINZA PRATA   |
|   | 1200010021300 | PRETO   |
|   | 1200010591300 | PERGAMON  |
|   |               | COLUNA PARA LAVATÓRIO CITY                                    |
|   | 1202010010300 | BRANCO  |
|   | 1202010020300 | PRETO   |
|   | 1202010590300 | PERGAMON  |
|   | 1202010770300 | CINZA PRATA   |
|  |               | COLUNA SUSPensa PARA LAVATÓRIO CITY                           |
|   | 1202020010300 | BRANCO  |
|   | 1202020590300 | PERGAMON  |
|   | 1202020020300 | PRETO   |
|  |               | ASSENTO ORIGINAL POLIPROPILENO SOFT<br>CLOSE CITY/LIKE        |
|   | 9209880010300 | BRANCO  |

|   |               |  |
|---|---------------|--|
|  |               | ASSENTO ORIGINAL POLIPROPILENO SOFT<br>CLOSE CITY/LIKE |
|  | 9209880020300 | PRETO  |
|  | 9209880590300 | ASSENTO ORIGINAL POLIPROPILENO SOFT<br>CLOSE CITY/LIKE |
|  | 9209880770300 | ASSENTO ORIGINAL POLIPROPILENO SOFT<br>CLOSE CITY/LIKE |



LIKE

| IMAGEM  | CÓDIGO        | DESCRIÇÃO   |
|---|---------------|---|
|    |               | KIT BACIA COM CAIXA, ASSENTO PP E COMPLEMENTOS DE INSTALAÇÃO LIKE |
|   | 1647230010300 | BRANCO  |
|   | 1647230590300 | PERGAMON  |
|    |               | CONJUNTO BACIA PARA CAIXA E CAIXA 3/6 LITROS LIKE                 |
|   | 1647700011300 | BRANCO  |
|   | 1647700591300 | PERGAMON  |
|   |               | CONJUNTO BACIA PARA CAIXA E CAIXA 3/6 LITROS SMART CLEAN LIKE     |
|   | 1647700014300 | BRANCO  |
|  |               | CONJUNTO BACIA PARA CAIXA E CAIXA 6 LITROS LIKE                   |
|   | 1647700010300 | BRANCO  |
|   | 1647700590300 | PERGAMON  |
|  |               | BACIA PARA CAIXA LIKE   |
|   | 1643550010300 | BRANCO  |
|   | 1643550590300 | PERGAMON  |
|  |               | CAIXA 3/6 LITROS HARPIC SMARTCLEAN                                |
|   | 1555700015301 | BRANCO  |

|  |   |  |
|--|---|--|
|      |   | <p>CAIXA 3/6 LITROS TOUCHLESS HARPIC BR</p>  |
|    | <p>1555700017301</p>  | <p>BRANCO</p>  |
|    | <p>1645100015300</p>  | <p>CAIXA PARA ACOPLAR ACIONAMENTO LATERAL LIKE/ACESSO - NORMA ABNT 9050</p> <p>BRANCO</p>                        |
|   | <p>1645600015300</p> <p>1645600025300</p> <p>1645600595300</p> <p>1645600775300</p> | <p>CAIXA PARA ACOPLAR 3/6 LITROS LIKE/NET/CITY</p> <p>BRANCO</p> <p>PRETO</p> <p>PERGAMON</p> <p>CINZA PRATA</p> |
|  | <p>1645600013300</p>  | <p>CAIXA PARA ACOPLAR 6 LITROS LIKE</p> <p>BRANCO</p>  |
|  | <p>1645600593300</p>  | <p>CAIXA PARA ACOPLAR 6 LITROS LIKE</p> <p>PERGAMON</p>  |
|  | <p>1643050010300</p> <p>1643050590300</p>   | <p>BACIA CONVENCIONAL LIKE</p> <p>BRANCO</p> <p>PERGAMON</p>   |

|   |               |   |
|---|---------------|---|
|    |               | LAVATÓRIO PARA COLUNA 495X410 FURO CENTRAL SEM LADRAO |
|   | 1640010011300 | BRANCO  |
|   | 1640010591300 | PERGAMON  |
|    |               | COLUNA PARA LAVATÓRIO LIKE                            |
|   | 1642010010300 | BRANCO  |
|   | 1642010590300 | PERGAMON  |
|    |               | COLUNA SUSPensa PARA LAVATÓRIO LIKE                   |
|   | 1642020010300 | BRANCO  |
|   | 1642020590300 | PERGAMON  |
|  |               | ASSENTO ORIGINAL POLIPROPILENO LIKE/ART               |
|   | 9509810010100 | BRANCO  |
|  |               | ASSENTO ORIGINAL POLIPROPILENO SOFT CLOSE CITY/LIKE   |
|   | 9209880010300 | BRANCO  |
|  |               | ASSENTO ORIGINAL POLIPROPILENO SOFT CLOSE CITY/LIKE   |
|   | 9209880020300 | PRETO   |

|   |                      |   |
|---|----------------------|---|
|   | <p>9509810590100</p> | <p>ASSENTO ORIGINAL POLIPROPILENO LIKE/ART</p> <p>PERGAMON</p>                    |
|  | <p>9209880590300</p> | <p>ASSENTO ORIGINAL POLIPROPILENO SOFT<br/>CLOSE CITY/LIKE</p> <p>PERGAMON</p>    |
|  | <p>9209880770300</p> | <p>ASSENTO ORIGINAL POLIPROPILENO SOFT<br/>CLOSE CITY/LIKE</p> <p>CINZA PRATA</p> |

NET

| IMAGEM  | CÓDIGO        | DESCRIÇÃO  |
|---|---------------|--|
|    | 1927230010300 | KIT BACIA COM CAIXA, ASSENTO PP E COMPLEMENTOS DE INSTALAÇÃO NET |
|    | 1927700012300 | CONJUNTO BACIA PARA CAIXA E CAIXA SMART CLEAN CELITE NET         |
|   | 1927700010300 | CONJUNTO BACIA PARA CAIXA E CAIXA 3/6 LITROS NET                 |
|  | 1923640010300 | BACIA PARA CAIXA CELITE NET RIMLESS                              |
|  | 1555700015301 | CAIXA 3/6 LITROS HARPIC SMARTCLEAN                               |
|   | 1555700017301 | CAIXA 3/6 LITROS TOUCHLESS HARPIC BR                             |

|   |                      |  |
|---|----------------------|--|
|   | <p>1645600593300</p> | <p>CAIXA PARA ACOPLAR 6 LITROS LIKE</p> <p>PERGAMON</p>          |
|  | <p>1920360011300</p> | <p>LAVATORIO APOIO/SUSPENSO 400X300 CELITE NET</p> <p>BRANCO</p> |
|   | <p>9929810010300</p> | <p>ASSENTO ORIGINAL POLIPROPILENO NET/FIRST</p> <p>BRANCO</p>    |

AZALEA





| IMAGEM  | CÓDIGO        | DESCRIÇÃO   |
|---|---------------|---|
|    | 1917230010300 | KIT BACIA COM CAIXA, ASSENTO PP SOFT CLOSE E COMPLEMENTOS DE INSTALAÇÃO AZÁLEA<br>BRANCO    |
|   |               |   |
|     | 1917270010300 | KIT BACIA CONVENCIONAL, ASSENTO PP SOFT CLOSE E COMPLEMENTOS DE INSTALAÇÃO AZÁLEA<br>BRANCO |
|   |               |   |
|   | 1917700013300 | CONJUNTO BACIA PARA CAIXA E CAIXA SMART CLEAN AZALEA<br>BRANCO                              |
|   | 1917700770300 | CINZA PRATA   |
|   | 1917700020300 | PRETO   |
|   | 1917700590300 | PERGAMON  |
|  | 1917700010300 | CONJUNTO BACIA PARA CAIXA E CAIXA 3/6 LITROS P AZALEA<br>BRANCO                             |
|   | 1917700770300 | CINZA PRATA   |
|   | 1917700020300 | PRETO   |
|   | 1917700590300 | PERGAMON  |
|   | 1917700014300 | CONJUNTO BACIA SAÍDA HORIZONTAL E CAIXA SMART CLEAN AZALEA<br>BRANCO                        |
|   | 1917700770300 | CINZA PRATA   |
|   | 1917700590300 | PERGAMON  |
|   | 1917700020300 | PRETO   |
|  | 1917700011300 | CONJUNTO BACIA SAIDA HORIZONTAL E CAIXA 3/6 LITROS P AZALEA<br>BRANCO                       |
|   |               |   |

|   |               |  |
|---|---------------|--|
|     |               | CONJUNTO BACIA CONVENCIONAL,<br>LAVATORIO E COLUNA AZALEA PLUS |
|   | 1917310010300 | BRANCO   |
|   | 1917310590300 | PERGAMON   |
|   | 1917310020300 | PRETO  |
|   | 1917310770300 | CINZA PRATA  |
|     |               | BACIA PARA CAIXA AZALEA PLUS                                   |
|   | 1913510010300 | BRANCO   |
|   | 1913510020300 | PRETO  |
|   | 1913510590300 | PERGAMON   |
|   | 1913510770300 | CINZA PRATA  |
|     |               | BACIA PARA CAIXA 3/6 LITROS SAIDA<br>HORIZONTAL AZALEA         |
|   | 1913570011300 | BRANCO   |
|  |               | CAIXA P 3/6 LITROS AZALEA/ACESSO/ECO                           |
|   | 1555700015300 | BRANCO   |
|   | 1555700035300 | CINZA  |
|   | 1555700595300 | PERGAMON   |
|   | 1555700025300 | PRETO  |
|   | 1555700775300 | CINZA PRATA  |
|   | 1555700505300 | OCRE   |
|  |               | CAIXA 3/6 LITROS HARPIC SMARTCLEAN                             |
|   | 1555700015301 | BRANCO   |
|   |               | CAIXA 3/6 LITROS TOUCHLESS HARPIC BR                           |
|   | 1555700017301 | BRANCO   |



|   |               |  |
|---|---------------|--|
|     |               | BACIA CONVENCIONAL AZALEA PLUS                               |
|   | 1913010010300 | BRANCO   |
|   | 1913010590300 | PERGAMON   |
|   | 1913010020300 | PRETO  |
|   | 1913010770300 | CINZA PRATA  |
|    |               | BIDE 3 FUROS COM DUCHA COM LADRAO AZALEA                     |
|   | 1914300010300 | BRANCO   |
|   | 1914300020300 | PRETO  |
|   | 1914300590300 | PERGAMON   |
|    |               | LAVATÓRIO PARA COLUNA 470X385 FURO CENTRAL SEM LADRÃO AZALEA |
|   | 1910070011300 | BRANCO   |
|   | 1910070591300 | PERGAMON   |
|   | 1910070021300 | PRETO  |
|   | 1910070771300 | CINZA PRATA  |
|  |               | LAVATÓRIO SUSPENSO 430X325 FURO APONTADO SEM LADRÃO AZALEA   |
|   | 1910380013300 | BRANCO   |
|   | 1910380023300 | PRETO  |
|   | 1910380773300 | CINZA PRATA  |
|   | 1910380593300 | PERGAMON   |
|  |               | COLUNA PARA LAVATÓRIO AZALEA                                 |
|   | 1912010010300 | BRANCO   |
|   | 1912010590300 | PERGAMON   |
|   | 1912010770300 | CINZA PRATA  |
|   | 1912010020300 | PRETO  |
|  |               | ASSENTO ORIGINAL CONFORT PLUS                                |
|   | 3909860010100 | BRANCO   |

|   |                      |  |
|---|----------------------|--|
|     | <p>3909840010100</p> | <p>ASSENTO ORIGINAL CONFORT SOPRADO</p> <p>BRANCO</p>                    |
|    | <p>9909810010300</p> | <p>ASSENTO ORIGINAL POLIPROPILENO ECO UNIVERSAL</p> <p>BRANCO</p>        |
|    | <p>9909810020300</p> | <p>ASSENTO ORIGINAL POLIPROPILENO ECO UNIVERSAL</p> <p>PRETO</p>         |
|  | <p>9909810030300</p> | <p>ASSENTO ORIGINAL POLIPROPILENO ECO UNIVERSAL</p> <p>CINZA</p>         |
|  | <p>9909810480300</p> | <p>ASSENTO ORIGINAL POLIPROPILENO ECO UNIVERSAL</p> <p>CINZA PLATINA</p> |
|  | <p>9909810500300</p> | <p>ASSENTO ORIGINAL POLIPROPILENO ECO UNIVERSAL</p> <p>OCRE</p>          |

|   |                      |  |
|---|----------------------|--|
|     | <p>9909810570300</p> | <p>ASSENTO ORIGINAL POLIPROPILENO ECO UNIVERSAL</p> <p>BISCUIT</p>     |
|    | <p>9909810580300</p> | <p>ASSENTO ORIGINAL POLIPROPILENO ECO UNIVERSAL</p> <p>BEGE AREIA</p>  |
|    | <p>9909810590300</p> | <p>ASSENTO ORIGINAL POLIPROPILENO ECO UNIVERSAL</p> <p>PERGAMON</p>    |
|  | <p>9909810770300</p> | <p>ASSENTO ORIGINAL POLIPROPILENO ECO UNIVERSAL</p> <p>CINZA PRATA</p> |





SAVEIRO

| IMAGEM  | CÓDIGO        | DESCRIÇÃO   |
|---|---------------|---|
|    |               | COMBO BACIA, CAIXA P 3/6 LITROS E ASSENTO ECO SAVEIRO           |
|   | 1027920012300 | BRANCO  |
|   | 1027920502300 | OCRE  |
|   | 1027920022300 | PRETO   |
|   | 1027920592300 | PERGAMON  |
|   | 1027920032300 | CINZA   |
|   | 1027920772300 | CINZA PRATA   |
|    |               | COMBO BACIA, CAIXA 3/6 LITROS SMART CLEAN E ASSENTO ECO SAVEIRO |
|   | 1027930010300 | BRANCO  |
|  |               | COMBO BACIA E CAIXA 6 LITROS P E ASSENTO ECO SAVEIRO            |
|   | 1027920013300 | BRANCO  |
|   | 1027920033300 | CINZA   |
|   | 1027920503300 | OCRE  |
|   | 1027920773300 | CINZA PRATA   |
|   | 1027920023300 | PRETO   |
|   | 1027920593300 | PERGAMON  |
|  |               | CONJUNTO BACIA + CAIXA SMART CLEAN 3/6 LITROS SAVEIRO BRANCO    |
|   | 1027700016300 | BRANCO  |
|  |               | CONJUNTO BACIA E CAIXA 3/6 LITROS PARA SAVEIRO                  |
|   | 1027700011300 | BRANCO  |
|   | 1027700771300 | CINZA PRATA   |
|   | 1027700772300 | CINZA PRATA   |
|   | 1027700021300 | PRETO   |
|   | 1027700591300 | PERGAMON  |
|   | 1027700031300 | CINZA   |
|   | 1027700501300 | OCRE  |

|   |               |   |
|---|---------------|---|
|     |               | CONJUNTO BACIA E CAIXA 6 LITROS PARA SAVEIRO            |
|   | 1027700012300 | BRANCO  |
|   | 1027700592300 | PERGAMON  |
|   | 1027700502300 | OCRE  |
|   | 1027700032300 | CINZA   |
|   | 1027700022300 | PRETO   |
|    |               | COMBO BACIA CONVENCIONAL E ASSENTO PP ECO SAVEIRO       |
|   | 1027780014300 | BRANCO  |
|   | 1027780504300 | OCRE  |
|   | 1027780034300 | CINZA   |
|   | 1027780594300 | PERGAMON  |
|   | 1027780774300 | CINZA PRATA   |
|   |               | CONJUNTO BACIA CONVENCIONAL, LAVATORIO E COLUNA SAVEIRO |
|   | 1027330010300 | BRANCO  |
|   | 1027330590300 | PERGAMON  |
|   | 1027330030300 | CINZA   |
|   | 1027330020300 | PRETO   |
|   | 1027330500300 | OCRE  |
|   | 1027330770300 | CINZA PRATA   |
|   |               | BACIA PARA CAIXA SAIDA HORIZONTAL SAVEIRO               |
|   | 1023570010300 | BRANCO  |
|  |               | BACIA PARA CAIXA SAVEIRO                                |
|   | 1023550010300 | BRANCO  |
|   | 1023550590300 | PERGAMON  |
|   | 1023550770300 | CINZA PRATA   |
|   | 1023550030300 | CINZA   |
|   | 1023550500300 | OCRE  |
|   | 1023550020300 | PRETO   |
|  |               | CAIXA P 3/6 LITROS AZALEA/ACESSO/ECO                    |
|   | 1555700015300 | BRANCO  |
|   | 1555700505300 | OCRE  |
|   | 1555700775300 | CINZA PRATA   |
|   | 1555700035300 | CINZA   |
|   | 1555700595300 | PERGAMON  |
|   | 1555700025300 | PRETO   |

|   |               |   |
|---|---------------|---|
|     |               | CAIXA P 6 LITROS SAVEIRO                                      |
|   | 1555700012300 | BRANCO  |
|   | 1555700032300 | CINZA   |
|   | 1555700502300 | OCRE  |
|   | 1555700592300 | PERGAMON  |
|   | 1555700772300 | CINZA PRATA   |
|   | 1555700022300 | PRETO   |
|    |               | CAIXA 3/6 LITROS HARPIC SMARTCLEAN                            |
|   | 1555700015301 | BRANCO  |
|     |               | CAIXA 3/6 LITROS TOUCHLESS HARPIC BR                          |
|   | 1555700017301 | BRANCO  |
|  |               | BACIA CONVENCIONAL SAVEIRO                                    |
|   | 1023030010300 | BRANCO  |
|   | 1023030770300 | CINZA PRATA   |
|   | 1023030590300 | PERGAMON  |
|   | 1023030500300 | OCRE  |
|   | 1023030030300 | CINZA   |
|   | 1023030020300 | PRETO   |
|  |               | LAVATÓRIO PARA COLUNA 470X385 FURO CENTRAL SEM LADRÃO SAVEIRO |
|   | 1020070010300 | BRANCO  |
|   | 1020070500300 | OCRE  |
|   | 1020070590300 | PERGAMON  |
|   | 1020070020300 | PRETO   |
|   | 1020070770300 | CINZA PRATA   |
|   | 1020070030300 | CINZA   |
|  |               | COLUNA PARA LAVATÓRIO SAVEIRO                                 |
|   | 1022010010300 | BRANCO  |
|   | 1022010020300 | PRETO   |
|   | 1022010590300 | PERGAMON  |
|   | 1022010030300 | CINZA   |
|   | 1022010770300 | CINZA PRATA   |
|   | 1022010500300 | OCRE  |

|   |                      |  |
|---|----------------------|--|
|     | <p>3909860010100</p> | <p>ASSENTO ORIGINAL CONFORT PLUS</p> <p>BRANCO</p>                       |
|    | <p>3909840010100</p> | <p>ASSENTO ORIGINAL CONFORT SOPRADO</p> <p>BRANCO</p>                    |
|    | <p>9909810010300</p> | <p>ASSENTO ORIGINAL POLIPROPILENO ECO UNIVERSAL</p> <p>BRANCO</p>        |
|  | <p>9909810020300</p> | <p>ASSENTO ORIGINAL POLIPROPILENO ECO UNIVERSAL</p> <p>PRETO</p>         |
|  | <p>9909810030300</p> | <p>ASSENTO ORIGINAL POLIPROPILENO ECO UNIVERSAL</p> <p>CINZA</p>         |
|  | <p>9909810480300</p> | <p>ASSENTO ORIGINAL POLIPROPILENO ECO UNIVERSAL</p> <p>CINZA PLATINA</p> |

|   |                      |   |
|---|----------------------|---|
|     |                      | <p>ASSENTO ORIGINAL POLIPROPILENO ECO UNIVERSAL</p> |
|   | <p>9909810500300</p> | <p>OCRE</p>   |
|    |                      | <p>ASSENTO ORIGINAL POLIPROPILENO ECO UNIVERSAL</p> |
|   | <p>9909810570300</p> | <p>BISCUIT</p>                                      |
|    |                      | <p>ASSENTO ORIGINAL POLIPROPILENO ECO UNIVERSAL</p> |
|   | <p>9909810580300</p> | <p>BEGE AREIA</p>                                   |
|  |                      | <p>ASSENTO ORIGINAL POLIPROPILENO ECO UNIVERSAL</p> |
|   | <p>9909810590300</p> | <p>PERGAMON</p>                                     |
|  |                      | <p>ASSENTO ORIGINAL POLIPROPILENO ECO UNIVERSAL</p> |
|   | <p>9909810770300</p> | <p>CINZA PRATA</p>                                  |



**ACESSO**

| IMAGEM  | CÓDIGO        | DESCRIÇÃO   |
|---|---------------|---|
|     | 1317230012300 | KIT BACIA COM CAIXA ACIONAMENTO LATERAL, ASSENTO PP COM ABERTURA E COMPLEMENTOS DE INSTALAÇÃO ACESSO CELITE       |
|    | 1317230010300 | KIT BACIA COM CAIXA, ASSENTO PP COM ABERTURA E COMPLEMENTOS DE INSTALAÇÃO ACESSO CELITE                           |
|     | 1317230013300 | KIT BACIA COM CAIXA ACIONAMENTO LATERAL, ASSENTO PP SOFT CLOSE E COMPLEMENTOS DE INSTALAÇÃO ACESSO CONFORT CELITE |
|  | 1317230011300 | KIT BACIA COM CAIXA, ASSENTO PP SOFT CLOSE E COMPLEMENTOS DE INSTALAÇÃO ACESSO CONFORT CELITE                     |
|   | 1317270010300 | BACIA CONVENCIONAL COM ABERTURA, COMPLEMENTOS DE INSTALAÇÃO E ASSENTO POLIPROPILENO ACESSO CELITE                 |
|   | 1317270011300 | BACIA CONVENCIONAL SEM ABERTURA, COM COMPLEMENTOS DE INSTALAÇÃO ASSENTO POLIPROPILENO ACESSO CONFORT CELITE       |

|   |                      |   |
|---|----------------------|---|
|       |                      | <p>CONJUNTO BACIA COM CAIXA SMART CLEAN<br/>HARPIC LINHA ACESSO CONFORT BRANCO</p>    |
|    | <p>1317700018300</p> | <p>BRANCO</p>   |
|    | <p>1317700016300</p> | <p>CONJUNTO BACIA PARA CAIXA E CAIXA<br/>SMART CLEAN ACESSO CELITE</p>                |
|   | <p>1317700013300</p> | <p>CONJUNTO BACIA PARA CAIXA E CAIXA 3/6<br/>LITROS P ACESSO CELITE</p>               |
|  | <p>1317700012300</p> | <p>CONJUNTO BACIA PARA CAIXA E CAIXA 3/6<br/>LITROS P ACESSO CONFORT CELITE</p>       |
|   | <p>1317310010300</p> | <p>CONJUNTO ACESSO BACIA CONVENCIONAL,<br/>LAVATORIO E COLUNA COM ABERTURA CELITE</p> |
|  | <p>1313590010300</p> | <p>BACIA PARA CAIXA COM ABERTURA FRONTAL<br/>ACESSO CELITE</p>                        |

|   |               |   |
|---|---------------|---|
|     |               | <p>BACIA PARA CAIXA SEM ABERTURA FRONTAL<br/>ACESSO CELITE - NORMA ABNT9050</p>   |
|   | 1313600010300 | BRANCO  |
|    | 1555700015300 | CAIXA P 3/6 LITROS AZALEA/ACESSO/ECO<br>BRANCO                                    |
|   | 1555700025300 | PRETO   |
|   | 1555700035300 | CINZA   |
|   | 1555700775300 | CINZA PRATA   |
|   | 1555700505300 | OCRE  |
|   | 1555700595300 | PERGAMON  |
|    | 1555700015301 | CAIXA 3/6 LITROS HARPIC SMARTCLEAN<br>BRANCO                                      |
|   | 1555700017301 | CAIXA 3/6 LITROS TOUCHLESS HARPIC BR<br>BRANCO                                    |
|  | 1645100015300 | CAIXA PARA ACOPLAR ACIONAMENTO<br>LATERAL LIKE/ACESSO - NORMA ABNT 9050<br>BRANCO |
|  | 1313090010300 | BACIA CONVENCIONAL ACESSO CELITE<br>BRANCO  |

|   |   |                                    |
|---|---|------------------------------------|
|     | <p>BACIA CONVENCIONAL SEM ABERTURA<br/>FRONTAL ACESSO CELITE - NORMA ABNT9050</p> | <p>1313100010300</p> <p>BRANCO</p> |
|    | <p>LAVATÓRIO PARA COLUNA 600X415 COM MESA<br/>ACESSO PLUS</p>                     | <p>1310550011300</p> <p>BRANCO</p> |
|    | <p>COLUNA SUSPensa PARA LAVATÓRIO<br/>ALOHA/RIVIERA/ACESSO</p>                    | <p>1562020010300</p> <p>BRANCO</p> |
|  | <p>ASSENTO ORIGINAL POLIPROPILENO ACESSO<br/>PLUS</p>                             | <p>3319810010100</p> <p>BRANCO</p> |
|  | <p>ASSENTO ORIGINAL CONFORT PLUS</p>  | <p>3909860010100</p> <p>BRANCO</p> |
|  | <p>ASSENTO ORIGINAL CONFORT SOPRADO</p>   | <p>3909840010100</p> <p>BRANCO</p> |

**ACESSO CONFORT**

| IMAGEM  | CÓDIGO        | DESCRIÇÃO   |
|---|---------------|---|
|     | 1317230013300 | KIT BACIA COM CAIXA ACIONAMENTO LATERAL, ASSENTO PP SOFT CLOSE E COMPLEMENTOS DE INSTALAÇÃO ACESSO CONFORT CELITE |
|    | 1317230011300 | KIT BACIA COM CAIXA, ASSENTO PP SOFT CLOSE E COMPLEMENTOS DE INSTALAÇÃO ACESSO CONFORT CELITE                     |
|     | 1317270011300 | BACIA CONVENCIONAL SEM ABERTURA, COM COMPLEMENTOS DE INSTALAÇÃO ASSENTO POLIPROPILENO ACESSO CONFORT CELITE       |
|  | 1317700012300 | CONJUNTO BACIA PARA CAIXA E CAIXA 3/6 LITROS P ACESSO CONFORT CELITE  |
|  | 1313600010300 | BACIA PARA CAIXA SEM ABERTURA FRONTAL ACESSO CELITE - NORMA ABNT9050  |

|   |               |  |
|---|---------------|--|
|     |               | CAIXA P 3/6 LITROS AZALEA/ACESSO/ECO                                   |
|   | 1555700015300 | BRANCO   |
|   | 1555700505300 | OCRE   |
|   | 1555700035300 | CINZA  |
|   | 1555700025300 | PRETO  |
|   | 1555700775300 | CINZA PRATA  |
| 1555700595300   | PERGAMON      |  |
|    |               | CAIXA 3/6 LITROS HARPIC SMARTCLEAN                                     |
|   | 1555700015301 | BRANCO   |
|     |               | CAIXA 3/6 LITROS TOUCHLESS HARPIC BR                                   |
|   | 1555700017301 | BRANCO   |
|  |               | CAIXA PARA ACOPLAR ACIONAMENTO LATERAL LIKE/ACESSO - NORMA ABNT 9050   |
|   | 1645100015300 | BRANCO   |
|  |               | BACIA CONVENCIONAL SEM ABERTURA FRONTAL ACESSO CELITE - NORMA ABNT9050 |
|   | 1313100010300 | BRANCO   |
|  |               | ASSENTO ORIGINAL CONFORT PLUS  |
|   | 3909860010100 | BRANCO   |



ASSENTO ORIGINAL CONFORT SOPRADO

3909840010100

BRANCO

KIDS

| IMAGEM  | CÓDIGO        | DESCRIÇÃO  |
|---|---------------|--|
|    | 1087230010300 | KIT BACIA COM CAIXA, ASSENTO PP E COMPLEMENTOS DE INSTALAÇÃO CELITE KIDS     |
|   |               | BRANCO   |
|     | 1087270010300 | BACIA CONVENCIONAL COM COMPLEMENTOS DE INSTALAÇÃO ASSENTO POLIPROPILENO KIDS |
|   |               | BRANCO   |
|   | 1087690011300 | CONJUNTO BACIA COM CAIXA 3/6 LITROS INFANTIL                                 |
|   |               | BRANCO   |
|  | 1082540010300 | BACIA CONVENCIONAL 6,8 LITROS CELITE INFANTIL                                |
|   |               | BRANCO   |
|  | 1082550010300 | BACIA PARA CAIXA INFANTIL  |
|   |               | BRANCO   |
|  | 1085700015300 | CAIXA ECOFLUSH 3/6 LITROS ACIONAMENTO NA TAMPA INFANTIL                      |
|   |               | BRANCO   |





ASSENTO ORIGINAL POLIPROPILENO BACIA  
INFANTIL

3089810010100

BRANCO

LAVATÓRIOS

| IMAGEM  | CÓDIGO        | DESCRIÇÃO  |
|---|---------------|--|
|    | 1710010011300 | LAVATÓRIO SUSPENSO/COLUNA G 420X360 FURO CENTRAL SEM LADRÃO<br>BRANCO  |
|    | 1330390013300 | LAVATÓRIO SUSPENSO P 380X280 FURO APONTADO SEM LADRÃO CELITE<br>BRANCO |
|   | 1270370013300 | LAVATÓRIO SUSPENSO M 465X340 FURO APONTADO SEM LADRÃO CELITE<br>BRANCO |
|  | 1040360011300 | LAVATÓRIO APOIO/SUSPENSO ECO 400X300 CELITE<br>BRANCO                  |
|  | 1040380011300 | LAVATÓRIO SUSPENSO 430X290 FURO CENTRAL SEM LADRÃO ORATÓRIO<br>BRANCO  |
|  | 1040410011301 | LAVATÓRIO SUSPENSO/APOIO 400X230 COM MESA CELITE BRANCO<br>BRANCO      |



1040140011300

LAVATÓRIO SUSPENSO CANTO P 420X345X300  
CELITE

BRANCO









1040130011300



LAVATÓRIO SUSPENSO DE CANTO M 30X39X12  
FURO CENTRAL SEM LADRÃO CELITE

BRANCO

**CUBAS**

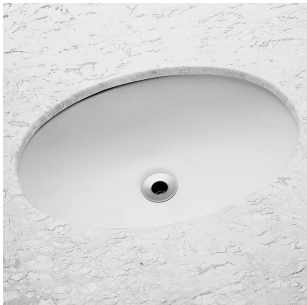
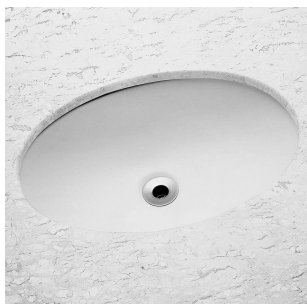
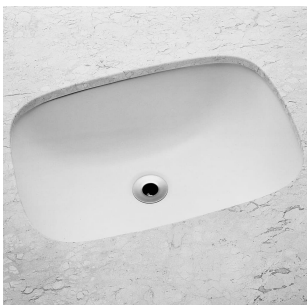

| IMAGEM  | CÓDIGO        | DESCRIÇÃO  |
|---|---------------|--|
|    | 1730500017300 | CUBA DE SOBREPOR/EMBUTIR 410X410 SEM MESA BASIC Q3                 |
|   |               | BRANCO   |
|    | 1101380011301 | CUBA DE SOBREPOR RETANGULAR 450X430 CELITE BRANCO                  |
|   |               | BRANCO   |
|   | 1101360010300 | CUBA DE SOBREPOR RETANGULAR 520X460 FURO CENTRAL COM LADRÃO CELITE |
|   |               | BRANCO   |
|  | 1101340011301 | CUBA DE SOBREPOR RETANGULAR 650X430 CELITE BRANCO                  |
|   |               | BRANCO   |
|  | 1101450017300 | CUBA DE SOBREPOR/EMBUTIR OVAL 430X310 CELITE                       |
|   | 1101450597300 | PERGAMON   |
|  | 1101510017300 | CUBA DE SOBREPOR/EMBUTIR REDONDA 310 DIAMETRO CELITE               |
|   | 1101510597300 | PERGAMON   |
|   | 1101510027300 | PRETO  |

|   |                      |  |
|---|----------------------|--|
|     | <p>1101600017300</p> | <p>CUBA DE SOBREPOR/EMBUTIR REDONDA 360<br/>DIAMENTRO CELITE</p> <p>BRANCO</p>     |
|    | <p>1101350017300</p> | <p>CUBA SOBREPOR / EMBUTIR RETANGULAR<br/>390X310 CELITE</p> <p>BRANCO</p>         |
|    | <p>1101480017300</p> | <p>CUBA SOBREPOR OVAL 435X310 SEM MESA E<br/>SEM LADRÃO CELITE</p> <p>BRANCO</p>   |
|   | <p>1101480777300</p> | <p>CINZA PRATA</p>   |
|   | <p>1101480597300</p> | <p>PERGAMON</p>  |
|   | <p>1101480027300</p> | <p>PRETO</p>   |
|  | <p>1761460011300</p> | <p>CUBA SOBREPOR OVAL 520X445 FURO<br/>CENTRAL SEM LADRÃO CELITE</p> <p>BRANCO</p> |
|   | <p>1761460591300</p> | <p>PERGAMON</p>  |
|   | <p>1761460591300</p> | <p>PERGAMON</p>  |
|  | <p>1101390011301</p> | <p>CUBA SOBREPOR RETANGULAR 550X430<br/>CELITE BRANCO</p> <p>BRANCO</p>            |
|  | <p>1101370011301</p> | <p>CUBA SOBREPOR RETANGULAR 600X330<br/>CELITE BRANCO</p> <p>BRANCO</p>            |

|  |               |   |
|--|---------------|---|
|     |               | CUBA DE EMBUTIR OVAL 390X300 SEM MESA E SEM LADRÃO CELITE       |
|  | 1101190017300 | BRANCO  |
|  | 1101190027300 | PRETO   |
|  | 1101190597300 | PERGAMON  |
|  | 1101190777300 | CINZA PRATA   |
|    |               | CUBA DE EMBUTIR OVAL 490X325 SEM MESA E SEM LADRÃO CELITE       |
|  | 1761170017300 | BRANCO  |
|  | 1761170777300 | CINZA PRATA   |
|  | 1761170297300 | AGUA MARINHA  |
|  | 1761170027300 | PRETO   |
|  | 1761170597300 | PERGAMON  |
|  | 1761170037300 | CINZA   |
|   |               | CUBA DE EMBUTIR OVAL 510X350 SEM MESA COM LADRÃO CELITE         |
|  | 1101160016300 | BRANCO  |
|  |               | CUBA DE EMBUTIR RETANGULAR 505X370 SEM MESA E SEM LADRÃO CELITE |
|  | 1761070017300 | BRANCO  |
|  | 1761070597300 | PERGAMON  |
|  |               | CUBA EMBUTIR REDONDA 365 DIAMETRO SEM MESA E SEM LADRÃO         |
|  | 1101290017300 | BRANCO  |
|  | 1101290027300 | PRETO   |
|  | 1101290597300 | PERGAMON  |
|  | 1101290777300 | CINZA PRATA   |

TANQUES

| IMAGEM  | CÓDIGO        | DESCRIÇÃO  |
|---|---------------|--|
|    | 1512640013300 | TANQUE G BUILDERS 590X520 FURO APONTADO SEM LADRÃO<br>BRANCO         |
|    | 1512660013300 | TANQUE G 600X520 COM MESA CELITE<br>BRANCO                           |
|  | 1512620017300 | TANQUE GG 655X565 SEM FURO SEM LADRÃO CELITE<br>BRANCO               |
|  | 1512680013300 | TANQUE M BUILDERS 565X485, FURO APONTADO SEM LADRÃO BRANCO<br>BRANCO |
|  | 1512650013300 | TANQUE M 535X485 SEM MESA CELITE<br>BRANCO                           |
|  | 1512630013300 | TANQUE P FURO APONTADO SEM LADRÃO CELITE<br>BRANCO                   |

|   |               |  |
|---|---------------|--|
|   |               | TANQUE PP FURO APONTADO SEM LADRÃO<br>CELITE |
|  | 1512670013300 | BRANCO                                       |



PRO

| IMAGEM   | CÓDIGO               | DESCRIÇÃO  |
|--|----------------------|--|
|    | <p>1087240010300</p> | <p>KIT MICTORIO ECO COM VALVULA E<br/>COMPLEMENTOS DE INSTALAÇÃO</p> <p>BRANCO</p> |
|   | <p>1082510010300</p> | <p>BACIA TURCA CELITE</p> <p>BRANCO</p>  |
|  | <p>1082850010300</p> | <p>MICTÓRIO COM SIFÃO ECO CELITE</p> <p>BRANCO</p>                                 |

**Processada em: 01/03/2021 07:57:53**





**Processada em: 01/03/2021 07:57:53**

AS SEN  
LTO S

Celite

SMART

| IMAGEM  | CÓDIGO        | DESCRIÇÃO  |
|---|---------------|--|
|    |               | ASSENTO ORIGINAL POLIPROPILENO RIVIERA/SMART       |
|   | 3129810010100 | BRANCO   |
|    |               | ASSENTO ORIGINAL SOFT CLOSE RIVIERA/SMART          |
|   | 3129880010300 | BRANCO   |
|   |               | ASSENTO ORIGINAL TERMOFIXO SOFT CLOSE SMART        |
|   | 3169830010300 | BRANCO   |
|  |               | ASSENTO ORIGINAL POLIPROPILENO RIVIERA/SMART PRETO |
|   | 3129810020100 | PRETO  |
|  |               | ASSENTO ORIGINAL SOFT CLOSE RIVIERA/SMART          |
|   | 3129880020300 | PRETO  |
|  |               | ASSENTO ORIGINAL TERMOFIXO SOFT CLOSE SMART/SLIM   |
|   | 3169830070300 | METRÓPOLE  |

|   |                      |  |
|---|----------------------|--|
|     | <p>3169830100300</p> | <p>ASSENTO ORIGINAL TERMOFIXO SOFT CLOSE<br/>SMART/SLIM</p> <p>NOITE</p>         |
|    | <p>3169830140300</p> | <p>ASSENTO ORIGINAL TERMOFIXO SOFT CLOSE<br/>SMART/SLIM</p> <p>BRANCO MATTE</p>  |
|    | <p>3129810590100</p> | <p>ASSENTO ORIGINAL POLIPROPILENO<br/>RIVIERA/SMART PERGAMON</p> <p>PERGAMON</p> |
|  | <p>3129880590300</p> | <p>ASSENTO ORIGINAL SOFT CLOSE<br/>RIVIERA/SMART</p> <p>PERGAMON</p>             |
|  | <p>3169830660300</p> | <p>ASSENTO ORIGINAL TERMOFIXO SOFT CLOSE<br/>SMART/SLIM</p> <p>CASTANHA</p>      |



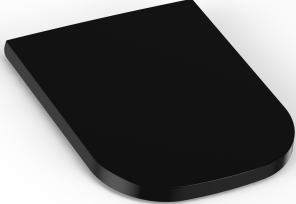

# Celite

## ELITE

| IMAGEM  | CÓDIGO        | DESCRIÇÃO  |
|---|---------------|--|
|  | 3749880010300 | ASSENTO ORIGINAL POLIPROPILENO SOFT<br>CLOSE ELITE<br>BRANCO |
|  | 3749880020300 | ASSENTO ORIGINAL POLIPROPILENO SOFT<br>CLOSE ELITE<br>PRETO  |



VIP

| IMAGEM  | CÓDIGO        | DESCRIÇÃO  |
|---|---------------|--|
|    |               | ASSENTO ORIGINAL POLIPROPILENO SOFT<br>CLOSE CITY/LIKE |
|   | 9209880010300 | BRANCO   |
|    |               | ASSENTO ORIGINAL POLIPROPILENO SOFT<br>CLOSE CITY/LIKE |
|   | 9209880020300 | PRETO  |
|  |               | ASSENTO ORIGINAL POLIPROPILENO SOFT<br>CLOSE CITY/LIKE |
|   | 9209880590300 | PERGAMON   |
|  |               | ASSENTO ORIGINAL POLIPROPILENO SOFT<br>CLOSE CITY/LIKE |
|   | 9209880770300 | CINZA PRATA  |





## LIFE







| IMAGEM  | CÓDIGO        | DESCRIÇÃO   |
|---|---------------|---|
|    |               | ASSENTO ORIGINAL POLIPROPILENO PLUS<br>LIFE       |
|   | 3989810010300 | BRANCO  |
|    |               | ASSENTO ORIGINAL POLIPROPILENO SOFT<br>CLOSE LIFE |
|   | 3989880010300 | BRANCO  |
|  |               | ASSENTO ORIGINAL POLIPROPILENO SOFT<br>CLOSE LIFE |
|   | 3989880590300 | PERGAMON  |







# Celite

## FIT

| IMAGEM  | CÓDIGO        | DESCRIÇÃO   |
|---|---------------|---|
|    |               | ASSENTO ORIGINAL FIT CONFORT                          |
|   | 3669840010300 | BRANCO  |
|    |               | ASSENTO ORIGINAL POLIPROPILENO FIT PLUS               |
|   | 9669810011300 | BRANCO  |
|  |               | ASSENTO ORIGINAL POLIPROPILENO FIT PLUS<br>SOFT CLOSE |
|   | 9669880010300 | BRANCO  |
|  |               | ASSENTO ORIGINAL TERMOFIXO SOFT CLOSE<br>FIT          |
|   | 3669830010300 | BRANCO  |
|  |               | ASSENTO ORIGINAL POLIPROPILENO FIT PLUS               |
|   | 9669810021300 | PRETO   |
|  |               | ASSENTO ORIGINAL POLIPROPILENO FIT PLUS<br>SOFT CLOSE |
|   | 9669880020300 | PRETO   |

|   |                      |   |
|---|----------------------|---|
|    |                      | <p>ASSENTO ORIGINAL POLIPROPILENO FIT PLUS</p>                |
|   | <p>9669810291300</p> | <p>AGUA MARINHA</p>   |
|    |                      | <p>ASSENTO ORIGINAL POLIPROPILENO FIT PLUS<br/>SOFT CLOSE</p> |
|   | <p>9669880290300</p> | <p>AGUA MARINHA</p>   |
|    |                      | <p>ASSENTO ORIGINAL POLIPROPILENO FIT PLUS</p>                |
|  | <p>9669810591300</p> | <p>PERGAMON</p>   |
|  |                      | <p>ASSENTO ORIGINAL POLIPROPILENO FIT PLUS<br/>SOFT CLOSE</p> |
|   | <p>9669880590300</p> | <p>PERGAMON</p>   |
|  |                      | <p>ASSENTO ORIGINAL POLIPROPILENO FIT PLUS</p>                |
|  | <p>9669810771300</p> | <p>CINZA PRATA</p>  |
|   |                      | <p>ASSENTO ORIGINAL POLIPROPILENO FIT PLUS<br/>SOFT CLOSE</p> |
|  | <p>9669880770300</p> | <p>CINZA PRATA</p>  |

CITY

| IMAGEM  | CÓDIGO  | DESCRIÇÃO  |
|---|---|--|
|    | 9209880010300   | ASSENTO ORIGINAL POLIPROPILENO SOFT<br>CLOSE CITY/LIKE<br>BRANCO |
|   |    | 9209880020300  |
|  |   | 9209880590300  |
|   |  | 9209880770300  |



LIKE

| IMAGEM  | CÓDIGO        | DESCRIÇÃO  |
|---|---------------|--|
|    |               | ASSENTO ORIGINAL POLIPROPILENO LIKE/ART                |
|   | 9509810010100 | BRANCO   |
|    |               | ASSENTO ORIGINAL POLIPROPILENO SOFT<br>CLOSE CITY/LIKE |
|   | 9209880010300 | BRANCO   |
|  |               | ASSENTO ORIGINAL POLIPROPILENO SOFT<br>CLOSE CITY/LIKE |
|   | 9209880020300 | PRETO  |
|  |               | ASSENTO ORIGINAL POLIPROPILENO LIKE/ART                |
|   | 9509810590100 | PERGAMON   |
|  |               | ASSENTO ORIGINAL POLIPROPILENO SOFT<br>CLOSE CITY/LIKE |
|   | 9209880590300 | PERGAMON   |
|  |               | ASSENTO ORIGINAL POLIPROPILENO SOFT<br>CLOSE CITY/LIKE |
|   | 9209880770300 | CINZA PRATA  |











# Celite





## NET

| IMAGEM  | CÓDIGO        | DESCRIÇÃO   |
|---|---------------|---|
|  | 9929810010300 | ASSENTO ORIGINAL POLIPROPILENO<br>NET/FIRST<br><br>BRANCO |













**AZALEA**

| IMAGEM  | CÓDIGO        | DESCRIÇÃO                                    |
|---|---------------|--|
|    |               | ASSENTO ORIGINAL CONFORT PLUS                |
|   | 3909860010100 | BRANCO                                       |
|    |               | ASSENTO ORIGINAL CONFORT SOPRADO             |
|   | 3909840010100 | BRANCO                                       |
|   |               | ASSENTO ORIGINAL POLIPROPILENO ECO UNIVERSAL |
|   | 9909810010300 | BRANCO                                       |
|  |               | ASSENTO ORIGINAL POLIPROPILENO ECO UNIVERSAL |
|   | 9909810020300 | PRETO  |
|  |               | ASSENTO ORIGINAL POLIPROPILENO ECO UNIVERSAL |
|   | 9909810030300 | CINZA  |
|  |               | ASSENTO ORIGINAL POLIPROPILENO ECO UNIVERSAL |
|   | 9909810480300 | CINZA PLATINA                                |

|   |                      |   |
|---|----------------------|---|
|     |                      | <p>ASSENTO ORIGINAL POLIPROPILENO ECO UNIVERSAL</p> |
|   | <p>9909810500300</p> | <p>OCRE</p>   |
|    |                      | <p>ASSENTO ORIGINAL POLIPROPILENO ECO UNIVERSAL</p> |
|   | <p>9909810570300</p> | <p>BISCUIT</p>                                      |
|    |                      | <p>ASSENTO ORIGINAL POLIPROPILENO ECO UNIVERSAL</p> |
|   | <p>9909810580300</p> | <p>BEGE AREIA</p>                                   |
|  |                      | <p>ASSENTO ORIGINAL POLIPROPILENO ECO UNIVERSAL</p> |
|   | <p>9909810590300</p> | <p>PERGAMON</p>                                     |
|  |                      | <p>ASSENTO ORIGINAL POLIPROPILENO ECO UNIVERSAL</p> |
|   | <p>9909810770300</p> | <p>CINZA PRATA</p>                                  |

SAVEIRO

| IMAGEM  | CÓDIGO        | DESCRIÇÃO  |
|---|---------------|--|
|    | 3909860010100 | ASSENTO ORIGINAL CONFORT PLUS<br>BRANCO                          |
|   |               |  |
|    | 3909840010100 | ASSENTO ORIGINAL CONFORT SOPRADO<br>BRANCO                       |
|   |               |  |
|   | 9909810010300 | ASSENTO ORIGINAL POLIPROPILENO ECO<br>UNIVERSAL<br>BRANCO        |
|   |               |  |
|  | 9909810020300 | ASSENTO ORIGINAL POLIPROPILENO ECO<br>UNIVERSAL<br>PRETO         |
|   |               |  |
|  | 9909810030300 | ASSENTO ORIGINAL POLIPROPILENO ECO<br>UNIVERSAL<br>CINZA         |
|   |               |  |
|  | 9909810480300 | ASSENTO ORIGINAL POLIPROPILENO ECO<br>UNIVERSAL<br>CINZA PLATINA |
|   |               |  |

|   |                      |   |
|---|----------------------|---|
|     |                      | <p>ASSENTO ORIGINAL POLIPROPILENO ECO UNIVERSAL</p> |
|   | <p>9909810500300</p> | <p>OCRE</p>   |
|    |                      | <p>ASSENTO ORIGINAL POLIPROPILENO ECO UNIVERSAL</p> |
|   | <p>9909810570300</p> | <p>BISCUIT</p>                                      |
|    |                      | <p>ASSENTO ORIGINAL POLIPROPILENO ECO UNIVERSAL</p> |
|   | <p>9909810580300</p> | <p>BEGE AREIA</p>                                   |
|  |                      | <p>ASSENTO ORIGINAL POLIPROPILENO ECO UNIVERSAL</p> |
|   | <p>9909810590300</p> | <p>PERGAMON</p>                                     |
|  |                      | <p>ASSENTO ORIGINAL POLIPROPILENO ECO UNIVERSAL</p> |
|   | <p>9909810770300</p> | <p>CINZA PRATA</p>                                  |

**ACESSO**

| IMAGEM   | CÓDIGO               | DESCRIÇÃO   |
|--|----------------------|---|
|   | <p>3909860010100</p> | <p>ASSENTO ORIGINAL CONFORT PLUS</p> <p>BRANCO</p>              |
|   | <p>3909840010100</p> | <p>ASSENTO ORIGINAL CONFORT SOPRADO</p> <p>BRANCO</p>           |
|  | <p>3319810010100</p> | <p>ASSENTO ORIGINAL POLIPROPILENO ACESSO PLUS</p> <p>BRANCO</p> |





**ACESSO CONFORT**

| IMAGEM  | CÓDIGO        | DESCRIÇÃO                        |
|---|---------------|----------------------------------|
|  |               | ASSENTO ORIGINAL CONFORT PLUS    |
|   | 3909860010100 | BRANCO                           |
|  |               | ASSENTO ORIGINAL CONFORT SOPRADO |
|   | 3909840010100 | BRANCO                           |



## KIDS







| IMAGEM  | CÓDIGO        | DESCRIÇÃO   |
|---|---------------|---|
|  | 3089810010100 | ASSENTO ORIGINAL POLIPROPILENO BACIA INFANTIL<br>BRANCO |

# COMPLE- -MENTOS E REPOSI- ÇÃO

Celite

REPAROS

| IMAGEM   | CÓDIGO        | DESCRIÇÃO  |
|--|---------------|--|
|  <p>ANEL DE VEDAÇÃO<br/>Incepa Celite logosa<br/>COM GUIA</p> | 3009510010100 | ANEL DE VEDAÇÃO COM GUIA PARA BACIA SANITARIA<br><br>SEM COR |
|   | BL00041CRR    | BOTAO ACIONAMENTO LATERAL 6L CROMADO<br><br>SEM COR          |
|    | BL0004300R    | ESPUDEFE BITOLA 5<br><br>SEM COR                             |
|   | 1969110013100 | KIT MECANISMO 6 LITROS ACIONAMENTO SUPERIOR<br><br>SEM COR   |
|  <p>Roca<br/>EM1<br/>MECANISMO UNIVERSAL TOUCHLESS</p>      | BL00233PRR    | MECANISMO DUPLO ACIONAMENTO TOUCHLESS ROCA<br><br>SEM COR    |
|    | 3969110001100 | MECANISMO UNIVERSAL DUPLO ACIONAMENTO<br><br>SEM COR         |

|   |                      |  |
|---|----------------------|--|
|    | <p>1969110005100</p> | <p>REPOSIÇÃO BOTÃO DE ACIONAMENTO 48 MILIMETROS 6 LITROS</p> <p>SEM COR</p>        |
|    | <p>1969110002100</p> | <p>REPOSIÇÃO BOTÃO DE ACIONAMENTO 98 MILIMETROS 3/6 LITROS</p> <p>SEM COR</p>      |
|    | <p>1969110003100</p> | <p>REPOSIÇÃO GASKET CONICO E FIXAÇÃO</p> <p>SEM COR</p>                            |
|   | <p>1969110007100</p> | <p>REPOSIÇÃO KIT MECANISMO 3/6 LITROS</p> <p>SEM COR</p>                           |
|  | <p>1969110000100</p> | <p>REPOSICAO MECANISMO DE ENTRADA D'AGUA PARA CAIXA DE DESCARGA</p> <p>SEM COR</p> |
|  | <p>1969110001100</p> | <p>REPOSIÇÃO MECANISMO DE SAIDA 3/6 LITROS</p> <p>SEM COR</p>                      |

|  |                      |   |
|--|----------------------|---|
|    | <p>1969110006100</p> | <p>REPOSIÇÃO MECANISMO SAIDA D'AGUA 6 LITROS</p> <p>SEM COR</p>             |
|   | <p>1969110004100</p> | <p>REPOSIÇÃO VEDAÇÃO PARA CAIXA DESCARGA PLANO E FIXAÇÃO</p> <p>SEM COR</p> |
|   | <p>BL00038BRR</p>    | <p>TUBO RETO PARA BACIA SAIDA HORIZONTAL/DUAL</p> <p>BRANCO</p>             |
|  | <p>1969110011100</p> | <p>REFIL PASTILHA CLEANING DEVICE</p> <p>AZUL</p>                           |





REPAROS LOUÇA

| IMAGEM  | CÓDIGO            | DESCRIÇÃO  |
|---|-------------------|--|
|  | <p>AV0007500R</p> | <p>CJ FIXACAO P/ LAVATORIO SUSPENSO</p> <p>SEM COR</p> |



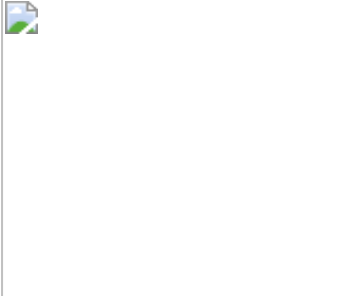





**COMPLEMENTOS CELITE**

| IMAGEM  | CÓDIGO            | DESCRIÇÃO   |
|---|-------------------|---|
|   | <p>B5008R0CR3</p> | <p>FLEXIVEL DE ALIMENTAÇÃO 400 MM DE AÇO INOX TRANÇADO COM CANOPLA</p> <p>CROMADO<br/>Caixa master: 6</p> |
|  | <p>B5007R0CR3</p> | <p>FLEXIVEL 300 MM AÇO INOX TRANÇADO COM CANOPLA</p> <p>CROMADO<br/>Caixa master: 48</p>                  |



COMPLEMENTOS DE LOUÇ

| IMAGEM  | CÓDIGO        | DESCRIÇÃO  |
|---|---------------|--|
|    | 3006380000100 | <p>KIT INSTALACAO PARA BACIA CONVENCIONAL</p> <p>SEM COR</p> |
|    | 3009750005500 | <p>CONJUNTO DE FIXAÇÃO PARA TANQUE P/M/G</p> <p>SEM COR</p>  |
|  | 3009750010100 | <p>CONJUNTO FIXACAO TIPO SUPORTE EM L</p> <p>SEM COR</p>     |
|  | 3009759000100 | <p>FIXAÇÃO (BACIA/ BIDE/ LAV) S-10 CR</p> <p>SEM COR</p>     |
|  | 3009750006100 | <p>FIXAÇÃO PARA LAVATÓRIOS</p> <p>SEM COR</p>                |
|  | 3009759010100 | <p>FIXACAO PARA MICTORIO PEQUENO S-10</p> <p>SEM COR</p>     |

|   |                      |  |
|---|----------------------|--|
|   | <p>3009759030100</p> | <p>FIXACAO PARA TANQUE GG/G BUILDERS S-12</p> <p>SEM COR</p> |
|  | <p>3009630910100</p> | <p>FIXACAO PARA LAVATORIO AZALEA</p> <p>CROMADO</p>          |

#### Preços

Para consultar o preço do produto, acesse <https://portalsistema.br.roca.net/>.

*\*Caso não tenha acesso converse com seu representante.*

#### Proposta de Compra

As propostas de compra estão sujeitas à nossa confirmação e o seu embarque à conformidade de sua produção.

**Processada em: 01/03/2021 07:57:53**

**Modificações ou descontinuação de produtos**

A Roca Brasil reserva o direito de modificar e/ou retirar de linha seus produtos e cores sem prévio aviso.

**Medidas e cores**

As medidas e cores de louças sanitárias estão sujeitas à pequenas variações, de acordo com a tolerância da indústria cerâmica e normas ABNT.

**Notas importantes**

Os assentos que compõem as fotos nas bacias podem ser de caráter ilustrativo e podem não estar inclusos no valor total dos produtos.

Importante verificar a validade desta tabela.

**Múltiplos de pallet e caixa Master**

Os múltiplos de pallet e caixa master são compostos por uma única cor.

**Combo de Bacias e assentos**

Os códigos de combos de bacias + assentos são somente para digitação. Na nota fiscal é registrado somente o código individual do produto.

*Imagens são meramente ilustrativas.*

Roca Sanitários Brasil Ltda.

Av. 14 de Dezembro, 2.800 - V. Mafalda - Jundiaí  
CEP 13206-105 - SP - Brasil  
Adm. Vendas - Tel 11 3230-0222

Export/Exportación Tel.: 55 113378-4660

Showroom

Av. Brasil, 2.188 - Jd. América  
CEP 01430-001 - SP - Brasil  
Tel.: 11 3061-5266

Pós Vendas - 0800 70 11 300  
[www.celite.com.br](http://www.celite.com.br)