

Incepa

Metais

Incepa

ERA

IMAGEM	CÓDIGO	DESCRIÇÃO
	B5000IRCRB	MISTURADOR PARA LAVATORIO DE MESA 3 FUROS BICA ALTA COM VALVULA DE ESCOAMENTO ERA CROMADO Caixa master: 2
	B5001IRCRB	MISTURADOR PARA LAVATORIO DE PAREDE COM VALVULA DE ESCOAMENTO ERA CROMADO Caixa master: 2
	B5002IRCRB	TORNEIRA PARA LAVATORIO DE MESA BICA ALTA ERA CROMADO Caixa master: 2
	B5003IRCRB	TORNEIRA PARA LAVATORIO DE PAREDE ERA CROMADO Caixa master: 2
	B5004IRCRB	DUCHA HIGIÊNICA COM DERIVAÇÃO ERA CROMADO CROMADO Caixa master: 2
	B5008IRCR0	ACABAMENTO DE REGISTRO BASE CELITE 1.1/4, 1.1/2 ERA (COMPATÍVEL COM A BASE DE REGISTRO DOCOL E CELITE DE 20 ESTRIAS) CROMADO Caixa master: 2

 <p>Incopa</p> <p>Novidade</p>	<p>B5005IRCR0</p>	<p>ACABAMENTO DE REGISTRO BASE CELITE 1/2, 3/4, 1 ERA (COMPATÍVEL COM A BASE DE REGISTRO DOCOL E CELITE DE 20 ESTRIAS)</p> <p>CROMADO Caixa master: 2</p>
 <p>Incopa</p> <p>Novidade</p>	<p>B5009IRCR0</p>	<p>ACABAMENTO DE REGISTRO BASE REFORMA 1.1/4, 1.1/2 ERA (COMPATÍVEL COM A BASE DE REGISTRO DECA E SIMILARES DE 16 ESTRIAS)</p> <p>CROMADO Caixa master: 2</p>
 <p>Incopa</p> <p>Novidade</p>	<p>B5006IRCR0</p>	<p>ACABAMENTO DE REGISTRO BASE REFORMA 1/2, 3/4, 1 ERA (COMPATÍVEL COM A BASE DE REGISTRO DECA E SIMILARES DE 16 ESTRIAS)</p> <p>CROMADO Caixa master: 2</p>



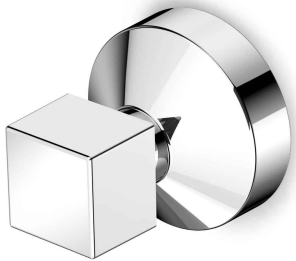

PLATINUM



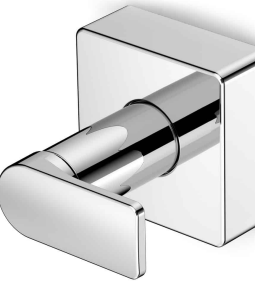

IMAGEM	CÓDIGO	DESCRIÇÃO
	B5001IDCRB	TORNEIRA PARA LAVATORIO DE MESA BICA ALTA PLATINUM
		CROMADO
	B5002IDCRB	TORNEIRA PARA LAVATORIO DE MESA BICA BAIXA PLATINUM
		CROMADO
	B5000IDCRB	TORNEIRA PARA LAVATORIO DE PAREDE PLATINUM
		CROMADO
	B5003IDCRB	DUCHA HIGIÊNICA COM DERIVAÇÃO PLATINUM
		CROMADO
	B5007IDCRB	ACABAMENTO DE REGISTRO BASE CELITE 1.1/4, 1.1/2 PLATINUM (COMPATÍVEL COM A BASE DE REGISTRO DOCOL E CELITE DE 20 ESTRIAS)
		CROMADO
	B5005IDCRB	ACABAMENTO DE REGISTRO BASE CELITE 1/2, 3/4, 1 PLATINUM (COMPATÍVEL COM A BASE DE REGISTRO DOCOL E CELITE DE 20 ESTRIAS)
		CROMADO

	<p>B5006IDCRB</p>	<p>ACABAMENTO DE REGISTRO BASE REFORMA 1.1/4, 1.1/2 PLATINUM (COMPATÍVEL COM A BASE DE REGISTRO DECA E SIMILARES DE 16 ESTRIAS)</p> <p>CROMADO</p>
	<p>B5004IDCRB</p>	<p>ACABAMENTO DE REGISTRO BASE REFORMA 1/2, 3/4, 1 PLATINUM (COMPATÍVEL COM A BASE DE REGISTRO DECA E SIMILARES DE 16 ESTRIAS)</p> <p>CROMADO</p>

NEO

IMAGEM	CÓDIGO	DESCRIÇÃO
	B5001I2CRB	MISTURADOR PARA LAVATORIO DE MESA 3 FUROS BICA ALTA COM VALVULA DE ESCOAMENTO NEO CROMADO Caixa master: 2
	B5002I2CRB	MISTURADOR PARA LAVATORIO DE PAREDE COM VALVULA DE ESCOAMENTO NEO CROMADO Caixa master: 2
	B5004I2CRB	TORNEIRA PARA LAVATORIO DE MESA BICA ALTA NEO CROMADO Caixa master: 2
	B5003I2CRB	TORNEIRA PARA LAVATORIO DE PAREDE NEO CROMADO Caixa master: 2
	B5005I2CRB	DUCHA HIGIÊNICA COM DERIVAÇÃO NEO CROMADO Caixa master: 2
	B5008I2CR0	ACABAMENTO DE REGISTRO BASE CELITE 1.1/4, 1.1/2 NEO (COMPATÍVEL COM A BASE DE REGISTRO DOCOL E CELITE DE 20 ESTRIAS) CROMADO Caixa master: 2

	<p>B5006I2CRB</p>	<p>ACABAMENTO DE REGISTRO BASE CELITE 1/2, 3/4, 1 NEO (COMPATÍVEL COM A BASE DE REGISTRO DOCOL E CELITE DE 20 ESTRIAS)</p> <p>CROMADO Caixa master: 2</p>
	<p>B5009I2CR0</p>	<p>ACABAMENTO DE REGISTRO BASE REFORMA 1.1/4, 1.1/2 NEO (COMPATÍVEL COM A BASE DE REGISTRO DECA E SIMILARES DE 16 ESTRIAS)</p> <p>CROMADO Caixa master: 2</p>
	<p>B5007I2CRB</p>	<p>ACABAMENTO DE REGISTRO BASE REFORMA 1/2, 3/4, 1 NEO (COMPATÍVEL COM A BASE DE REGISTRO DECA E SIMILARES DE 16 ESTRIAS)</p> <p>CROMADO Caixa master: 2</p>
	<p>B8001I2CR0</p>	<p>CABIDE DUPLO NEO</p> <p>CROMADO Caixa master: 4</p>
	<p>B8000I2CR0</p>	<p>CABIDE NEO</p> <p>CROMADO Caixa master: 4</p>
	<p>B8003I2CR0</p>	<p>PAPELEIRA NEO</p> <p>CROMADO Caixa master: 2</p>





	<p>B8004I2CR0</p>	<p>TOALHEIRO ANEL NEO</p> <p>CROMADO Caixa master: 2</p>
	<p>B8005I2CR0</p>	<p>TOALHEIRO BARRA 600 MM NEO</p> <p>CROMADO Caixa master: 2</p>
	<p>B8002I2CR0</p>	<p>SABONETEIRA NEO</p> <p>CROMADO Caixa master: 2</p>
	<p>B5000I2CR0</p>	<p>CHUVEIRO COM BRAÇO DE PAREDE QUADRADO 220 MM NEO</p> <p>CROMADO Caixa master: 2</p>

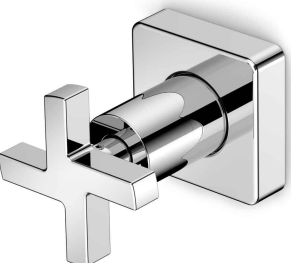



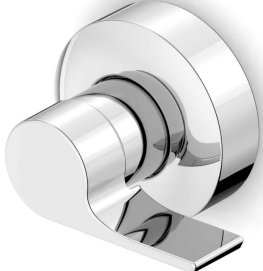

RECTA

IMAGEM	CÓDIGO	DESCRIÇÃO
	B5000IFCRB	MISTURADOR PARA LAVATORIO DE MESA 3 FUOS BICA ALTA COM VALVULA DE ESCOAMENTO RECTA CROMADO
	B5001IFCRB	MISTURADOR PARA LAVATORIO DE PAREDE COM VALVULA DE ESCOAMENTO RECTA CROMADO
	B5002IFCRB	TORNEIRA PARA LAVATORIO DE MESA BICA ALTA RECTA CROMADO
	B5003IFCRB	TORNEIRA PARA LAVATORIO DE PAREDE RECTA CROMADO
	B5004IFCRB	DUCHA HIGIÊNICA COM DERIVAÇÃO RECTA CROMADO
	B5008IFCR0	ACABAMENTO DE REGISTRO BASE CELITE 1.1/4, 1.1/2 RECTA (COMPATÍVEL COM A BASE DE REGISTRO DOCOL E CELITE DE 20 ESTRIAS) CROMADO Caixa master: 2

	<p>B5005IFCRB</p>	<p>ACABAMENTO DE REGISTRO BASE CELITE 1/2, 3/4, 1 RECTA (COMPATÍVEL COM A BASE DE REGISTRO DOCOL E CELITE DE 20 ESTRIAS)</p> <p>CROMADO</p>
	<p>B5009IFCR0</p>	<p>ACABAMENTO DE REGISTRO BASE REFORMA 1.1/4, 1.1/2 RECTA (COMPATÍVEL COM A BASE DE REGISTRO DECA E SIMILARES DE 16 ESTRIAS)</p> <p>CROMADO</p>
	<p>B5006IFCRB</p>	<p>ACABAMENTO DE REGISTRO BASE REFORMA 1/2, 3/4, 1 RECTA (COMPATÍVEL COM A BASE DE REGISTRO DECA E SIMILARES DE 16 ESTRIAS)</p> <p>CROMADO</p>

BOSS

IMAGEM	CÓDIGO	DESCRIÇÃO
	B500916CRB	MISTURADOR PARA LAVATORIO DE MESA 3 FUROS BICA ALTA 90° COM VALVULA DE ESCOAMENTO BOSS CROMADO Caixa master: 2
	B500316CRB	TORNEIRA PARA LAVATORIO DE MESA BICA ALTA 90° BOSS CROMADO Caixa master: 2
	B500416CRB	TORNEIRA PARA LAVATORIO DE PAREDE BOSS CROMADO Caixa master: 2
	B500216CRB	DUCHA HIGIÊNICA COM DERIVAÇÃO BOSS CROMADO Caixa master: 2
	B500816CR0	ACABAMENTO DE REGISTRO BASE CELITE 1.1/4, 1.1/2 BOSS (COMPATÍVEL COM A BASE DE REGISTRO DOCOL E CELITE DE 20 ESTRIAS) CROMADO Caixa master: 2
	B500616CRB	ACABAMENTO DE REGISTRO BASE CELITE 1/2, 3/4, 1 BOSS (COMPATÍVEL COM A BASE DE REGISTRO DOCOL E CELITE DE 20 ESTRIAS) CROMADO Caixa master: 2

	<p>B500716CR0</p>	<p>ACABAMENTO DE REGISTRO BASE REFORMA 1.1/4, 1.1/2 BOSS (COMPATÍVEL COM A BASE DE REGISTRO DECA E SIMILARES DE 16 ESTRIAS)</p> <p>CROMADO Caixa master: 2</p>
	<p>B500516CRB</p>	<p>ACABAMENTO DE REGISTRO BASE REFORMA 1/2, 3/4, 1 BOSS (COMPATÍVEL COM A BASE DE REGISTRO DECA E SIMILARES DE 16 ESTRIAS)</p> <p>CROMADO Caixa master: 2</p>
	<p>B501216CRB</p>	<p>MISTURADOR PARA COZINHA DE MESA BICA MÓVEL COM AREJADOR ARTICULADO BOSS</p> <p>CROMADO Caixa master: 2</p>
	<p>B501116CRB</p>	<p>MISTURADOR PARA COZINHA DE PAREDE BICA MÓVEL COM AREJADOR ARTICULADO BOSS</p> <p>CROMADO Caixa master: 2</p>
	<p>B500116CRB</p>	<p>TORNEIRA PARA COZINHA DE MESA BICA ALTA MÓVEL COM AREJADOR ARTICULADO BOSS</p> <p>CROMADO Caixa master: 2</p>
	<p>B501016CRB</p>	<p>TORNEIRA PARA COZINHA DE PAREDE BICA MÓVEL COM AREJADOR ARTICULADO BOSS</p> <p>CROMADO Caixa master: 2</p>









B500016CR0

CHUVEIRO COM BRAÇO DE PAREDE REDONDA
220 MM BOSS

CROMADO
Caixa master: 2

NEW

IMAGEM	CÓDIGO	DESCRIÇÃO
	B5019IGCR0	MONOCOMANDO PARA LAVATORIO DE MESA BICA ALTA NEW
		CROMADO
	B5018IGCR0	MONOCOMANDO PARA LAVATORIO DE MESA BICA BAIXA NEW
		CROMADO
	B5000IGCRB	MISTURADOR PARA LAVATORIO DE MESA 3 FUROS BICA ALTA COM VALVULA DE ESCOAMENTO NEW
		CROMADO
	B5001IGCRB	TORNEIRA PARA LAVATORIO DE MESA BICA ALTA NEW
		CROMADO
	B5002IGCRB	TORNEIRA PARA LAVATORIO DE MESA BICA BAIXA NEW
		CROMADO
	B5003IGCRB	TORNEIRA PARA LAVATORIO DE PAREDE NEW
		CROMADO

	<p>B5004IGCRB</p>	<p>DUCHA HIGIÊNICA COM DERIVAÇÃO NEW</p> <p>CROMADO</p>
	<p>B5008IGCRB</p>	<p>ACABAMENTO DE REGISTRO BASE CELITE 1.1/4, 1.1/2 NEW (COMPATÍVEL COM A BASE DE REGISTRO DOCOL E CELITE DE 20 ESTRIAS)</p> <p>CROMADO</p>
	<p>B5005IGCRB</p>	<p>ACABAMENTO DE REGISTRO BASE CELITE 1/2, 3/4, 1 NEW (COMPATÍVEL COM A BASE DE REGISTRO DOCOL E CELITE DE 20 ESTRIAS)</p> <p>CROMADO</p>
	<p>B5009IGCRB</p>	<p>ACABAMENTO DE REGISTRO BASE REFORMA 1.1/4, 1.1/2 NEW (COMPATÍVEL COM A BASE DE REGISTRO DECA E SIMILARES DE 16 ESTRIAS)</p> <p>CROMADO</p>
	<p>B5006IGCRB</p>	<p>ACABAMENTO DE REGISTRO BASE REFORMA 1/2, 3/4, 1 NEW (COMPATÍVEL COM A BASE DE REGISTRO DECA E SIMILARES DE 16 ESTRIAS)</p> <p>CROMADO</p>
	<p>B5020IGCR0</p>	<p>MONOCOMANDO PARA COZINHA DE MESA BICA ALTA COM AREJADOR ARTICULADO NEW</p> <p>CROMADO</p>



B5010IGCRB

TORNEIRA PARA COZINHA DE MESA BICA ALTA
COM AREJADOR ARTICULADO NEW

CROMADO





B5011IGCRB





TORNEIRA PARA COZINHA DE PAREDE COM
AREJADOR ARTICULADO NEW





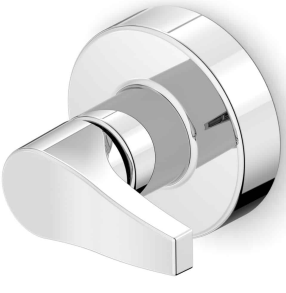
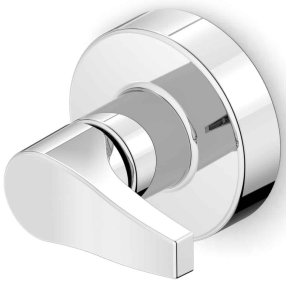

CROMADO

ART - N

IMAGEM	CÓDIGO	DESCRIÇÃO
	B5000IHCRB	TORNEIRA PARA LAVATORIO DE MESA BICA ALTA ART - N CROMADO
	B5002IHCRB	TORNEIRA PARA LAVATORIO DE PAREDE ART - N CROMADO

SUITE

IMAGEM	CÓDIGO	DESCRIÇÃO
	B5002I3CRB	MISTURADOR PARA LAVATORIO DE MESA 3 FUROS BICA ALTA COM VALVULA DE ESCOAMENTO SUITE CROMADO Caixa master: 2
	B5003I3CRB	TORNEIRA PARA LAVATORIO DE MESA BICA ALTA SUITE CROMADO Caixa master: 3
	B5004I3CRB	DUCHA HIGIÊNICA COM DERIVAÇÃO SUITE CROMADO Caixa master: 3
	B5009I3CRB	ACABAMENTO DE REGISTRO BASE CELITE 1.1/4, 1.1/2 SUITE (COMPATÍVEL COM A BASE DE REGISTRO DOCOL E CELITE DE 20 ESTRIAS) CROMADO Caixa master: 2
	B5001I3CRB	ACABAMENTO DE REGISTRO BASE CELITE 1/2, 3/4, 1 SUITE (COMPATÍVEL COM A BASE DE REGISTRO DOCOL E CELITE DE 20 ESTRIAS) CROMADO Caixa master: 4
	B5011I3CRB	ACABAMENTO DE REGISTRO BASE FABRIMAR 1/2, 3/4, 1 SUITE (COMPATÍVEL COM A BASE DE REGISTRO FABRIMAR DE 19 ESTRIAS) CROMADO

	<p>B5010I3CRB</p>	<p>ACABAMENTO DE REGISTRO BASE REFORMA 1.1/4, 1.1/2 SUITE (COMPATÍVEL COM A BASE DE REGISTRO DECA E SIMILARES DE 16 ESTRIAS)</p> <p>CROMADO Caixa master: 2</p>
	<p>B5000I3CRB</p>	<p>ACABAMENTO DE REGISTRO BASE REFORMA 1/2, 3/4, 1 SUITE (COMPATÍVEL COM A BASE DE REGISTRO DECA E SIMILARES DE 16 ESTRIAS)</p> <p>CROMADO Caixa master: 4</p>
	<p>B5005I3CRB</p>	<p>MISTURADOR PARA COZINHA DE MESA BICA MÓVEL COM AREJADOR ARTICULADO SUITE</p> <p>CROMADO Caixa master: 2</p>
	<p>B5006I3CRB</p>	<p>MISTURADOR PARA COZINHA DE PAREDE BICA MÓVEL COM AREJADOR ARTICULADO SUITE</p> <p>CROMADO Caixa master: 2</p>
	<p>B5007I3CRB</p>	<p>TORNEIRA PARA COZINHA DE MESA BICA ALTA MÓVEL COM AREJADOR ARTICULADO SUITE</p> <p>CROMADO Caixa master: 3</p>
	<p>B5008I3CRB</p>	<p>TORNEIRA PARA COZINHA DE PAREDE BICA MÓVEL COM AREJADOR ARTICULADO SUITE</p> <p>CROMADO Caixa master: 3</p>

	<p>B8000I3CR0</p>	<p>CABIDE SUITE</p> <p>CROMADO</p>
	<p>B8002I3CR0</p>	<p>PAPELEIRA SUITE</p> <p>CROMADO</p>
	<p>B8003I3CR0</p>	<p>TOALHEIRO ANEL SUITE</p> <p>CROMADO</p>
	<p>B8005I3CR0</p>	<p>TOALHEIRO BARRA 600 MM SUITE</p> <p>CROMADO</p>
	<p>B8004I3CR0</p>	<p>SABONETEIRA SUITE</p> <p>CROMADO</p>
	<p>B8001I3CR0</p>	<p>PRATELEIRA 400 MM SUITE</p> <p>CROMADO</p>









B8006I3CR0

KIT ACESSÓRIOS 5 PEÇAS SUITE | PAPELEIRA,
SABONETEIRA, TOALHEIRO ANEL, CABIDE E
TOALHEIRO BARRA 600MM.





CROMADO

THEMA

IMAGEM	CÓDIGO	DESCRIÇÃO
	B500514CRB	<p>MISTURADOR PARA LAVATORIO DE MESA 3 FUIROS BICA ALTA COM VALVULA DE ESCOAMENTO THEMA</p> <p>CROMADO Caixa master: 2</p>
	B500614CRB	<p>TORNEIRA PARA LAVATORIO DE MESA BICA ALTA THEMA</p> <p>CROMADO Caixa master: 3</p>
	B501214CRB	<p>TORNEIRA PARA LAVATORIO DE MESA BICA BAIXA THEMA</p> <p>CROMADO Caixa master: 3</p>
	B500714CRB	<p>DUCHA HIGIÊNICA COM DERIVAÇÃO THEMA</p> <p>CROMADO Caixa master: 3</p>
	B501314CRB	<p>ACABAMENTO DE REGISTRO BASE CELITE 1.1/4, 1.1/2 THEMA (COMPATÍVEL COM A BASE DE REGISTRO DOCOL E CELITE DE 20 ESTRIAS)</p> <p>CROMADO Caixa master: 2</p>
	B500414CRB	<p>ACABAMENTO DE REGISTRO BASE CELITE 1/2, 3/4, 1 THEMA (COMPATÍVEL COM A BASE DE REGISTRO DOCOL E CELITE DE 20 ESTRIAS)</p> <p>CROMADO Caixa master: 4</p>





	<p>B5014I4CRB</p>	<p>ACABAMENTO DE REGISTRO BASE REFORMA 1.1/4, 1.1/2 THEMA (COMPATÍVEL COM A BASE DE REGISTRO DECA E SIMILARES DE 16 ESTRIAS)</p> <p>CROMADO Caixa master: 2</p>
	<p>B5003I4CRB</p>	<p>ACABAMENTO DE REGISTRO BASE REFORMA 1/2, 3/4, 1 THEMA (COMPATÍVEL COM A BASE DE REGISTRO DECA E SIMILARES DE 16 ESTRIAS)</p> <p>CROMADO Caixa master: 4</p>
	<p>B5008I4CRB</p>	<p>MISTURADOR PARA COZINHA DE MESA BICA MÓVEL COM AREJADOR ARTICULADO THEMA</p> <p>CROMADO Caixa master: 2</p>
	<p>B5009I4CRB</p>	<p>MISTURADOR PARA COZINHA DE PAREDE BICA MÓVEL COM AREJADOR ARTICULADO THEMA</p> <p>CROMADO Caixa master: 2</p>
	<p>B5010I4CRB</p>	<p>TORNEIRA PARA COZINHA DE MESA BICA ALTA MÓVEL COM AREJADOR ARTICULADO THEMA</p> <p>CROMADO Caixa master: 3</p>
	<p>B5011I4CRB</p>	<p>TORNEIRA PARA COZINHA DE PAREDE BICA MÓVEL COM AREJADOR ARTICULADO THEMA</p> <p>CROMADO Caixa master: 3</p>



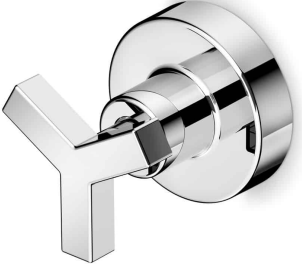
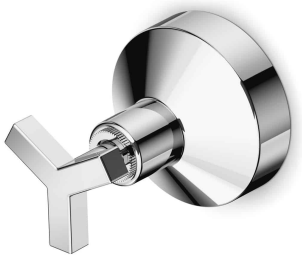
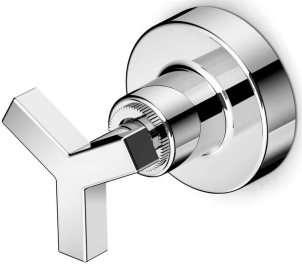

	B8001I4CR0	CABIDE DUPLO THEMA	CROMADO
	B8000I4CR0	CABIDE THEMA	CROMADO
	B8003I4CR0	PAPELEIRA THEMA	CROMADO
	B8004I4CR0	TOALHEIRO ANEL THEMA	CROMADO
	B8005I4CR0	TOALHEIRO BARRA 600 MM THEMA	CROMADO
	B8002I4CR0	SABONETEIRA THEMA	CROMADO

	<p>B8006I4CR0</p>	<p>KIT ACESSÓRIOS 5 PEÇAS THEMA PAPELEIRA, SABONETEIRA, TOALHEIRO ANEL, CABIDE E TOALHEIRO BARRA 600MM.</p> <p>CROMADO</p>
	<p>B5000I4CRB</p>	<p>CHUVEIRO COM BRAÇO DE PAREDE REDONDO 80 MM THEMA</p> <p>CROMADO Caixa master: 2</p>
	<p>B5002I4CRB</p>	<p>CHUVEIRO 80MM COM DESVIADOR E DUCHA MANUAL THEMA</p> <p>CROMADO Caixa master: 2</p>
	<p>B5001I4CRB</p>	<p>DUCHA MANUAL 80 MM COM DESVIADOR THEMA</p> <p>CROMADO Caixa master: 2</p>

AVANT

IMAGEM	CÓDIGO	DESCRIÇÃO
	B5003ICCRB	MISTURADOR PARA LAVATORIO DE MESA 3 FUROS BICA ALTA COM VALVULA DE ESCOAMENTO AVANT
		CROMADO
	B5001ICCRB	TORNEIRA PARA LAVATORIO DE MESA BICA ALTA AVANT
		CROMADO
	B5002ICCRB	TORNEIRA PARA LAVATORIO DE MESA BICA BAIXA AVANT
		CROMADO
	B5004ICCRB	DUCHA HIGIÊNICA COM DERIVAÇÃO AVANT
		CROMADO
	B5007ICCRB	ACABAMENTO DE REGISTRO BASE CELITE 1.1/4, 1.1/2 AVANT (COMPATÍVEL COM A BASE DE REGISTRO DOCOL E CELITE DE 20 ESTRIAS)
		CROMADO
	B5005ICCRB	ACABAMENTO DE REGISTRO BASE CELITE 1/2, 3/4, 1 AVANT (COMPATÍVEL COM A BASE DE REGISTRO DOCOL E CELITE DE 20 ESTRIAS)
		CROMADO

	<p>B5016ICCRB</p>	<p>ACABAMENTO DE REGISTRO BASE FABRIMAR 1/2, 3/4, 1 AVANT (COMPATÍVEL COM A BASE DE REGISTRO FABRIMAR DE 19 ESTRIAS)</p> <p>CROMADO</p>
	<p>B5008ICCRB</p>	<p>ACABAMENTO DE REGISTRO BASE REFORMA 1.1/4, 1.1/2 AVANT (COMPATÍVEL COM A BASE DE REGISTRO DECA E SIMILARES DE 16 ESTRIAS)</p> <p>CROMADO</p>
	<p>B5006ICCRB</p>	<p>ACABAMENTO DE REGISTRO BASE REFORMA 1/2, 3/4, 1 AVANT (COMPATÍVEL COM A BASE DE REGISTRO DECA E SIMILARES DE 16 ESTRIAS)</p> <p>CROMADO</p>
	<p>B5009ICCRB</p>	<p>MISTURADOR PARA COZINHA DE MESA BICA MÓVEL COM AREJADOR ARTICULADO AVANT</p> <p>CROMADO</p>
	<p>B5010ICCRB</p>	<p>MISTURADOR PARA COZINHA DE PAREDE BICA MÓVEL COM AREJADOR ARTICULADO AVANT</p> <p>CROMADO</p>
	<p>B5011ICCRB</p>	<p>TORNEIRA PARA COZINHA DE MESA BICA ALTA MÓVEL COM AREJADOR ARTICULADO AVANT</p> <p>CROMADO</p>

	<p>B5012ICCRB</p>	<p>TORNEIRA PARA COZINHA DE PAREDE BICA MÓVEL COM AREJADOR ARTICULADO AVANT</p> <p>CROMADO</p>
	<p>B5013ICCRB</p>	<p>TORNEIRA PARA TANQUE E JARDIM DE PAREDE COM BICO UNIÃO PLÁSTICO AVANT</p> <p>CROMADO</p>
	<p>B5014ICCRB</p>	<p>TORNEIRA PARA PIA E TANQUE DE PAREDE AVANT</p> <p>CROMADO</p>
	<p>B5015ICCRB</p>	<p>TORNEIRA PARA TANQUE E MÁQUINA DE PAREDE AVANT</p> <p>CROMADO</p>

ELEVEN

IMAGEM	CÓDIGO	DESCRIÇÃO
	B5000IKCRB	MISTURADOR PARA LAVATORIO DE MESA 3 FUROS BICA ALTA COM VALVULA DE ESCOAMENTO ELEVEN
		CROMADO
	B5001IKCRB	TORNEIRA PARA LAVATORIO DE MESA BICA ALTA ELEVEN
		CROMADO
	B5002IKCRB	DUCHA HIGIÊNICA COM DERIVAÇÃO ELEVEN
		CROMADO
	B5003IKCRB	DUCHA HIGIENICA SEM DERIVAÇÃO COM FLEXÍVEL PVC ELEVEN
		CROMADO
	B5007IKCRB	ACABAMENTO DE REGISTRO BASE CELITE 1.1/4, 1.1/2 ELEVEN (COMPATÍVEL COM A BASE DE REGISTRO DOCOL E CELITE DE 20 ESTRIAS)
		CROMADO
	B5004IKCRB	ACABAMENTO DE REGISTRO BASE CELITE 1/2, 3/4, 1 ELEVEN (COMPATÍVEL COM A BASE DE REGISTRO DOCOL E CELITE DE 20 ESTRIAS)
		CROMADO





















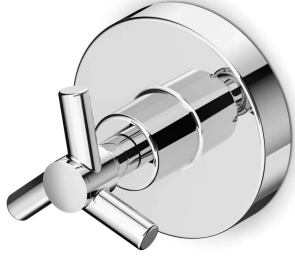





	<p>B5008IKCRB</p>	<p>ACABAMENTO DE REGISTRO BASE REFORMA 1.1/4, 1.1/2 ELEVEN (COMPATÍVEL COM A BASE DE REGISTRO DECA E SIMILARES DE 16 ESTRIAS)</p> <p>CROMADO</p>
	<p>B5005IKCRB</p>	<p>ACABAMENTO DE REGISTRO BASE REFORMA 1/2, 3/4, 1 ELEVEN (COMPATÍVEL COM A BASE DE REGISTRO DECA E SIMILARES DE 16 ESTRIAS)</p> <p>CROMADO</p>
	<p>B5009IKCRB</p>	<p>MISTURADOR PARA COZINHA DE MESA BICA MÓVEL COM AREJADOR ARTICULADO ELEVEN</p> <p>CROMADO</p>
	<p>B5010IKCRB</p>	<p>MISTURADOR PARA COZINHA DE PAREDE BICA MÓVEL COM AREJADOR ARTICULADO ELEVEN</p> <p>CROMADO</p>
	<p>B5011IKCRB</p>	<p>TORNEIRA PARA COZINHA DE MESA BICA ALTA MÓVEL COM AREJADOR ELEVEN</p> <p>CROMADO</p>
	<p>B5012IKCRB</p>	<p>TORNEIRA PARA COZINHA DE PAREDE BICA MÓVEL COM AREJADOR ELEVEN</p> <p>CROMADO</p>





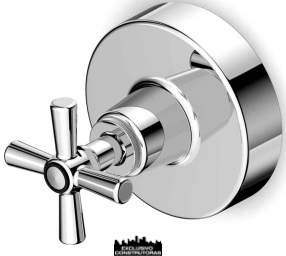
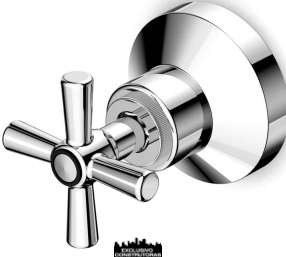

IMAGEM	CÓDIGO	DESCRIÇÃO
	B5007I9CRB	MISTURADOR PARA LAVATORIO DE MESA 3 FUOS BICA ALTA COM VALVULA DE ESCOAMENTO ZIP CROMADO Caixa master: 2
	B5000I9CR3	TORNEIRA PARA LAVATORIO DE MESA BICA ALTA ZIP CROMADO Caixa master: 4
	B5003I9CR3	TORNEIRA PARA LAVATORIO DE MESA BICA BAIXA ZIP CROMADO Caixa master: 4
	B5013I9CR3	DUCHA HIGIÊNICA COM DERIVAÇÃO ZIP CROMADO Caixa master: 4
	B5006I9CR3	DUCHA HIGIENICA SEM DERIVAÇÃO ZIP CROMADO Caixa master: 4
	B5011I9CR3	ACABAMENTO DE REGISTRO BASE CELITE 1.1/4, 1.1/2 ZIP (COMPATÍVEL COM A BASE DE REGISTRO DOCOL E CELITE DE 20 ESTRIAS) CROMADO Caixa master: 3

	<p>B5010I9CR3</p>	<p>ACABAMENTO DE REGISTRO BASE CELITE 1/2, 3/4, 1 ZIP (COMPATÍVEL COM A BASE DE REGISTRO DOCOL E CELITE DE 20 ESTRIAS)</p> <p>CROMADO Caixa master: 6</p>
	<p>B5016I9CR3</p>	<p>ACABAMENTO DE REGISTRO BASE FABRIMAR 1/2, 3/4, 1 ZIP (COMPATÍVEL COM A BASE DE REGISTRO FABRIMAR DE 19 ESTRIAS)</p> <p>CROMADO</p>
	<p>B5012I9CR3</p>	<p>ACABAMENTO DE REGISTRO BASE REFORMA 1.1/4, 1.1/2 ZIP (COMPATÍVEL COM A BASE DE REGISTRO DECA E SIMILARES DE 16 ESTRIAS)</p> <p>CROMADO Caixa master: 3</p>
	<p>B5009I9CR3</p>	<p>ACABAMENTO DE REGISTRO BASE REFORMA 1/2, 3/4, 1 ZIP (COMPATÍVEL COM A BASE DE REGISTRO DECA E SIMILARES DE 16 ESTRIAS)</p> <p>CROMADO Caixa master: 6</p>
	<p>B5014I9CRB</p>	<p>MISTURADOR PARA COZINHA DE MESA BICA MÓVEL COM AREJADOR ARTICULADO ZIP</p> <p>CROMADO Caixa master: 2</p>
	<p>B5015I9CRB</p>	<p>MISTURADOR PARA COZINHA DE PAREDE BICA MÓVEL COM AREJADOR ARTICULADO ZIP</p> <p>CROMADO Caixa master: 2</p>

	<p>B5008I9CR3</p>	<p>TORNEIRA PARA COZINHA DE MESA BICA ALTA MÓVEL COM AREJADOR ZIP</p> <p>CROMADO Caixa master: 4</p>
	<p>B5005I9CR3</p>	<p>TORNEIRA PARA COZINHA DE PAREDE BICA MÓVEL COM AREJADOR ZIP</p> <p>CROMADO Caixa master: 4</p>
	<p>B5004I9CR3</p>	<p>TORNEIRA PARA TANQUE E JARDIM DE PAREDE COM BICO UNIÃO PLÁSTICO ZIP</p> <p>CROMADO Caixa master: 4</p>
	<p>B5002I9CR3</p>	<p>TORNEIRA PARA TANQUE E MÁQUINA DE PAREDE ZIP</p> <p>CROMADO Caixa master: 3</p>
	<p>B5001I9CR3</p>	<p>TORNEIRA PARA PIA E TANQUE DE PAREDE ZIP</p> <p>CROMADO Caixa master: 4</p>
	<p>B8000I9CR0</p>	<p>KIT ACESSÓRIOS 5 PEÇAS ZIP PAPELEIRA, SABONETEIRA, TOALHEIRO BARRA 180MM, CABIDE E TOALHEIRO BARRA 450MM</p> <p>CROMADO</p>







ECO-N INCEPA

IMAGEM	CÓDIGO	DESCRIÇÃO
	B5000IQCR3	TORNEIRA PARA LAVATÓRIO DE MESA BICA ALTA ECO-N INCEPA
		CROMADO
	B5001IQCR3	TORNEIRA PARA LAVATÓRIO DE MESA BICA BAIXA ECO-N INCEPA
		CROMADO
	B5003IOCR3	ACABAMENTO DE REGISTRO BASE REFORMA 1.1/4, 1.1/2 (COMPATÍVEL COM A BASE DE REGISTRO DECA E SIMILARES DE 16 ESTRIAS)
		CROMADO
	B5002IOCR3	ACABAMENTO DE REGISTRO BASE REFORMA 1/2, 3/4, 1 (COMPATÍVEL COM A BASE DE REGISTRO DECA E SIMILARES DE 16 ESTRIAS)
		CROMADO
	B5002IQCR3	TORNEIRA PARA COZINHA DE MESA BICA ALTA MÓVEL COM AREJADOR ECO-N INCEPA
		CROMADO
	B5005IQCR3	TORNEIRA PARA COZINHA DE MESA BICA MÓVEL COM SAÍDA PARA FILTRO ECO-N INCEPA
		CROMADO

	<p>B5003IQCR3</p>	<p>TORNEIRA PARA COZINHA DE PAREDE BICA MÓVEL COM AREJADOR ECO-N INCEPA</p> <p>CROMADO</p>
	<p>B5006IQCR3</p>	<p>TORNEIRA PARA COZINHA DE PAREDE BICA MÓVEL COM SAÍDA PARA FILTRO ECO-N INCEPA</p> <p>CROMADO</p>
	<p>B5009IQCR3</p>	<p>TORNEIRA PARA TANQUE E JARDIM 100 MM DE PAREDE COM BICO UNIÃO PLÁSTICO ECO-N INCEPA</p> <p>CROMADO</p>
	<p>B5010IQCR3</p>	<p>TORNEIRA PARA TANQUE E JARDIM 130 MM DE PAREDE COM BICO UNIÃO PLÁSTICO ECO-N INCEPA</p> <p>CROMADO</p>
	<p>B5008IQCR3</p>	<p>TORNEIRA PARA TANQUE E JARDIM 70 MM DE PAREDE COM BICO UNIÃO PLÁSTICO ECO-N INCEPA</p> <p>CROMADO</p>
	<p>B5007IQCR3</p>	<p>TORNEIRA PARA TANQUE E MÁQUINA DE PAREDE ECO-N INCEPA</p> <p>CROMADO</p>

ECO INCEPA

IMAGEM	CÓDIGO	DESCRIÇÃO
	B5000IOCR3	TORNEIRA PARA LAVATÓRIO DE MESA BICA ALTA ECO INCEPA
		CROMADO
	B5001IOCR3	TORNEIRA PARA LAVATÓRIO DE MESA BICA BAIXA ECO INCEPA
		CROMADO
	B5025IOCR3	DUCHA HIGIENICA SEM DERIVAÇÃO ECO INCEPA
		CROMADO
	B5003IOCR3	ACABAMENTO DE REGISTRO BASE REFORMA 1.1/4, 1.1/2 (COMPATÍVEL COM A BASE DE REGISTRO DECA E SIMILARES DE 16 ESTRIAS)
		CROMADO
	B5002IOCR3	ACABAMENTO DE REGISTRO BASE REFORMA 1/2, 3/4, 1 (COMPATÍVEL COM A BASE DE REGISTRO DECA E SIMILARES DE 16 ESTRIAS)
		CROMADO
	B5004IOCR3	TORNEIRA PARA COZINHA DE MESA BICA ALTA MÓVEL COM AREJADOR ECO INCEPA
		CROMADO

	<p>B5007IOCR3</p>	<p>TORNEIRA PARA COZINHA DE MESA BICA MÓVEL COM SAÍDA PARA FILTRO ECO INCEPA</p> <p>CROMADO</p>
	<p>B5005IOCR3</p>	<p>TORNEIRA PARA COZINHA DE PAREDE BICA MÓVEL COM AREJADOR ECO INCEPA</p> <p>CROMADO</p>
	<p>B5008IOCR3</p>	<p>TORNEIRA PARA COZINHA DE PAREDE BICA MÓVEL COM SAÍDA PARA FILTRO ECO INCEPA</p> <p>CROMADO</p>
	<p>B5011IOCR3</p>	<p>TORNEIRA PARA TANQUE E JARDIM 100 MM DE PAREDE COM BICO UNIÃO PLÁSTICO ECO INCEPA</p> <p>CROMADO</p>
	<p>B5012IOCR3</p>	<p>TORNEIRA PARA TANQUE E JARDIM 130 MM DE PAREDE COM BICO UNIÃO PLÁSTICO ECO INCEPA</p> <p>CROMADO</p>
	<p>B5010IOCR3</p>	<p>TORNEIRA PARA TANQUE E JARDIM 70 MM DE PAREDE COM BICO UNIÃO PLÁSTICO ECO INCEPA</p> <p>CROMADO</p>





B5009IOCR3

TORNEIRA PARA TANQUE E MÁQUINA DE
PAREDE ECO INCEPA

CROMADO

WATERPRESS

IMAGEM	CÓDIGO	DESCRIÇÃO
		TORNEIRA PARA LAVATORIO DE MESA COM FEHCAMENTO AUTOMÁTICO
	B500018CRB	CROMADO Caixa master: 2
		TORNEIRA PARA LAVATORIO DE PAREDE COM FECHAMENTO AUTOMÁTICO
	B500118CRB	CROMADO Caixa master: 2
		VÁLVULA PARA MICTORIO DE PAREDE COM FECHAMENTO AUTOMÁTICO
	B500218CRB	CROMADO Caixa master: 2

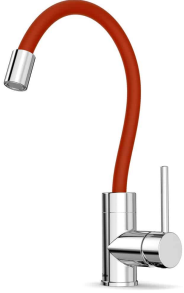

INCEPA COLORS

IMAGEM	CÓDIGO	DESCRIÇÃO
	B5001IECR0	MONOCOMANDO PARA COZINHA DE MESA BICA FLEXÍVEL PRETO INCEPA COLORS
	B5000IECR0	MONOCOMANDO PARA COZINHA DE MESA BICA FLEXÍVEL VERMELHO INCEPA COLORS

GOURMET INCEPA

IMAGEM	CÓDIGO	DESCRIÇÃO
	B5000INCR0	MONOCOMANDO PARA COZINHA DE MESA BICA EXTRAÍVEL COM 2 FUNÇÕES GOURMET CROMADO

UTILE

IMAGEM	CÓDIGO	DESCRIÇÃO
	B5001ITCR0	MONOCOMANDO PARA COZINHA DE MESA BICA EXTRAÍVEL "L" COM 2 FUNÇÕES ÚTILE CROMADO
	B5000ITCR0	MONOCOMANDO PARA COZINHA DE MESA BICA EXTRAÍVEL U" COM 2 FUNÇÕES ÚTILE CROMADO

KITCHEN INCEPA

IMAGEM	CÓDIGO	DESCRIÇÃO
	B5000IPCR0	MONOCOMANDO PARA COZINHA DE MESA BICA EXTRAÍVEL COM 2 FUNÇÕES KITCHEN CROMADO



MISANO

IMAGEM	CÓDIGO	DESCRIÇÃO
		MONOCOMANDO PARA LAVATORIO DE MESA BICA ALTA MISANO
	B5003IMCR0	CROMADO
		MONOCOMANDO PARA LAVATORIO DE MESA BICA BAIXA MISANO
	B5002IMCR0	CROMADO
		TORNEIRA PARA LAVATORIO DE MESA BICA ALTA MISANO
	B5001IMCR0	CROMADO
		TORNEIRA PARA LAVATORIO DE MESA BICA BAIXA MISANO
	B5000IMCR0	CROMADO
		ACABAMENTO PARA MONOCOMANDO DE BANHEIRA E CHUVEIRO MISANO (COM DESVIADOR)
	B5004IMCR0	CROMADO
		ACABAMENTO PARA MONOCOMANDO DE BANHEIRA OU CHUVEIRO MISANO
	B5005IMCR0	CROMADO

	<p>B5006IMCR0</p>	<p>BASE PARA MONOCOMANDO DE BANHEIRA E CHUVEIRO (COM DESVIADOR)</p> <p>CROMADO</p>
	<p>B5007IMCR0</p>	<p>BASE PARA MONOCOMANDO DE BANHEIRA OU CHUVEIRO</p> <p>CROMADO</p>
	<p>B5008IMCR0</p>	<p>MONOCOMANDO PARA COZINHA DE MESA BICA ALTA COM AREJADOR ARTICULADO MISANO</p> <p>CROMADO</p>

TRENTINO

IMAGEM	CÓDIGO	DESCRIÇÃO
	B5003ILCR0	MONOCOMANDO PARA LAVATORIO DE MESA BICA ALTA TRENTINO
		CROMADO
	B5002ILCR0	MONOCOMANDO PARA LAVATORIO DE MESA BICA BAIXA TRENTINO
		CROMADO
	B5001ILCR0	TORNEIRA PARA LAVATORIO DE MESA BICA ALTA TRENTINO
		CROMADO
	B5000ILCR0	TORNEIRA PARA LAVATORIO DE MESA BICA BAIXA TRENTINO
		CROMADO
	B5006IMCR0	BASE PARA MONOCOMANDO DE BANHEIRA E CHUVEIRO (COM DESVIADOR)
		CROMADO
	B5007IMCR0	BASE PARA MONOCOMANDO DE BANHEIRA OU CHUVEIRO
		CROMADO

	<p>B5004ILCR0</p>	<p>ACABAMENTO PARA MONOCOMANDO DE BANHEIRA E CHUVEIRO TRENTINO (COM DESVIADOR)</p> <p>CROMADO</p>
	<p>B5005ILCR0</p>	<p>ACABAMENTO PARA MONOCOMANDO DE BANHEIRA OU CHUVEIRO TRENTINO</p> <p>CROMADO</p>
	<p>B5009ILCR0</p>	<p>MONOCOMANDO PARA COZINHA DE MESA BICA ALTA COM AREJADOR ARTICULADO TRENTINO</p> <p>CROMADO</p>

FIRST

IMAGEM	CÓDIGO	DESCRIÇÃO
	B5001IBCR0	MONOCOMANDO PARA LAVATORIO DE MESA BICA ALTA FIRST
		CROMADO
	B5000IBCR0	MONOCOMANDO PARA LAVATORIO DE MESA BICA BAIXA FIRST
		CROMADO
	B5002IBCR0	MONOCOMANDO PARA BIDÊ SEM DUCHA FIRST
		CROMADO
	B5004IBCR0	MONOCOMANDO DE BANHEIRA OU CHUVEIRO FIRST
		CROMADO
	B5003IBCR0	MONOCOMANDO PARA BANHEIRA E CHUVEIRO FIRST (COM DESVIADOR)
		CROMADO
	B5006IBCR0	MONOCOMANDO PARA COZINHA DE MESA BICA ALTA COM AREJADOR ARTICULADO FIRST
		CROMADO



B5005IBCR0







MONOCOMANDO PARA COZINHA DE MESA
BICA BAIXA COM AREJADOR ARTICULADO
FIRST

CROMADO

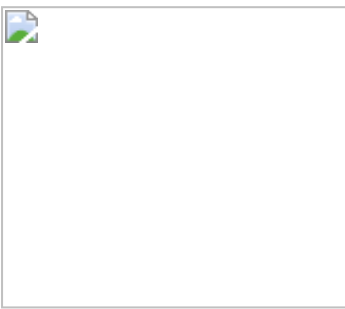
CHUVEIROS INCEPA





IMAGEM	CÓDIGO	DESCRIÇÃO
	B500016CR0	CHUVEIRO COM BRAÇO DE PAREDE REDONDA 220 MM BOSS CROMADO Caixa master: 2
	B500012CR0	CHUVEIRO COM BRAÇO DE PAREDE QUADRADO 220 MM NEO CROMADO Caixa master: 2
	B500014CRB	CHUVEIRO COM BRAÇO DE PAREDE REDONDO 80 MM THEMA CROMADO Caixa master: 2
	B500214CRB	CHUVEIRO 80MM COM DESVIADOR E DUCHA MANUAL THEMA CROMADO Caixa master: 2
	B500114CRB	DUCHA MANUAL 80 MM COM DESVIADOR THEMA CROMADO Caixa master: 2

COMPLEMENTOS INCEPA

IMAGEM	CÓDIGO	DESCRIÇÃO
	B5008R0CR3	FLEXIVEL DE ALIMENTAÇÃO 400 MM DE AÇO INOX TRANÇADO COM CANOPLA CROMADO Caixa master: 6
	B5007R0CR3	FLEXIVEL 300 MM AÇO INOX TRANÇADO COM CANOPLA CROMADO Caixa master: 48
	B5002R0CRB	SIFÃO PARA COZINHA 1.1/2" X DN40 X 300 MM COM ADAPTADOR DN50 CROMADO Caixa master: 4
	B5000R0CRB	SIFÃO PARA LAVATÓRIO 7/8" X DN40 X 300 MM CROMADO Caixa master: 4
	B5001R0CRB	SIFÃO PARA TANQUE 1.1/4" X DN40 X 200 MM COM ADAPTADOR DN50 CROMADO Caixa master: 4
	B5005IACRB	VÁLVULA DE ESCOAMENTO PARA COZINHA 3.1/2" X 1.1/2" COM CESTA DE METAL CROMADO Caixa master: 4

	<p>B5006IACRB</p>	<p>VÁLVULA DE ESCOAMENTO PARA COZINHA 4.1/2" X 1.1/2" COM CESTA DE METAL</p> <p>CROMADO Caixa master: 2</p>
	<p>B5003IACR3</p>	<p>VÁLVULA DE ESCOAMENTO PARA LAVATORIO 7/8" SEM LADRÃO COM TAMPA PLÁSTICA</p> <p>CROMADO Caixa master: 6</p>
	<p>B5013IACR3</p>	<p>VÁLVULA DE ESCOAMENTO PARA LAVATÓRIO 7/8" UNIVERSAL COM TAMPA PLÁSTICA</p> <p>CROMADO</p>
	<p>B5004IACR3</p>	<p>VÁLVULA DE ESCOAMENTO PARA TANQUE 1.1/4" SEM LADRÃO COM TAMPA PLÁSTICA</p> <p>CROMADO Caixa master: 6</p>

ACESSO INCEPA

IMAGEM	CÓDIGO	DESCRIÇÃO
		BARRA DE APOIO EM L" 700 MM ACESSO INCEPA (CONFORME NORMA ABNT NBR 9050)
	B500411CR0	CROMADO
		BARRA DE APOIO 300 MM ACESSO INCEPA
	B500011CR0	CROMADO
		BARRA DE APOIO 450 MM ACESSO INCEPA (CONFORME NORMA ABNT NBR 9050)
	B500111CR0	CROMADO
		BARRA DE APOIO 600 MM ACESSO INCEPA (CONFORME NORMA ABNT NBR 9050)
	B500211CR0	CROMADO
		BARRA DE APOIO 800 MM ACESSO INCEPA (CONFORME NORMA ABNT NBR 9050)
	B500311CR0	CROMADO





Processada em: 01/03/2021 07:58:22

Processada em: 01/03/2021 07:58:22

Móveis



Incepa

SUITE







IMAGEM	CÓDIGO	DESCRIÇÃO
	B60012M150	GABINETE INTEGRADO 2 GAVETAS 45X43 SUITE COM LAVATÓRIO WengueTX/Branco
	B60018M150	GABINETE INTEGRADO 2 PORTAS 60X34 SUITE COM LAVATÓRIO WengueTX/Branco
	B60013M150	GABINETE INTEGRADO 2 GAVETAS 45X43 SUITE COM LAVATÓRIO Argento/Branco
	B60015M150	GABINETE INTEGRADO 2 GAVETAS 55X43 SUITE COM LAVATÓRIO Argento/Branco
	B60017M150	GABINETE INTEGRADO 2 GAVETAS 65X43 SUITE COM LAVATÓRIO Argento/Branco

THEMA

IMAGEM	CÓDIGO	DESCRIÇÃO
	B60000M290	KIT GABINETE THEMA GAVETA E PORTA 60X38 COM CUBA BRANCO
	B60001M290	KIT GABINETE THEMA GAVETA E PORTA 60X38 COM CUBA WENGE
	B60005M290	KIT GABINETE THEMA GAVETA E PORTA 80X38 COM CUBA WENGE
	B60003M290	KIT GABINETE THEMA GAVETA E PORTA 60X38 COM CUBA Wengue/Branco
	B60007M290	KIT GABINETE THEMA GAVETA E PORTA 80X38 COM CUBA Wengue/Branco
	B60002M290	GABINETE THEMA GAVETA E PORTA 60X38 COM CUBA Branco/Wengue

	B60004M290	KIT GABINETE THEMA GAVETA E PORTA 80X38 COM CUBA Branco/Wengue
	B60006M290	KIT GABINETE THEMA GAVETA E PORTA 80X38 E CUBA Branco/Wengue

INCEPA LOFT

IMAGEM	CÓDIGO	DESCRIÇÃO
	B60046M140	KIT GABINETE LOFT GAVETA E PORTA 50X38 COM CUBA DE APOIO R1 BRANCO
	B60050M140	KIT GABINETE LOFT GAVETA E PORTA 60X38 COM CUBA DE APOIO Q6 BRANCO
	B60054M140	KIT GABINETE LOFT GAVETA E PORTA 60X38 COM CUBA DE APOIO R1 BRANCO
	B60058M140	KIT GABINETE LOFT GAVETA E PORTA 80X38 COM CUBA DE APOIO Q6 BRANCO
	B60042M140	KIT GABINETE LOFT 2 PORTAS 50X38 COM CUBA DE APOIO R1 BRANCO
	B60047M140	KIT GABINETE LOFT GAVETA E PORTA 50X38 COM CUBA DE APOIO R1 WENGE





	<p>B60051M140</p>	<p>KIT GABINETE LOFT GAVETA E PORTA 60X38 COM CUBA DE APOIO Q6</p> <p>WENGE</p>
	<p>B60055M140</p>	<p>KIT GABINETE LOFT GAVETA E PORTA 60X38 COM CUBA DE APOIO R1</p> <p>WENGE</p>
	<p>B60059M140</p>	<p>KIT GABINETE LOFT GAVETA E PORTA 80X38 COM CUBA DE APOIO Q6</p> <p>WENGE</p>
	<p>B60043M140</p>	<p>KIT GABINETE LOFT 2 PORTAS 50X38 COM CUBA DE APOIO R1</p> <p>WENGE</p>
	<p>B60049M140</p>	<p>KIT GABINETE LOFT GAVETA E PORTA 50X38 COM CUBA DE APOIO R1</p> <p>Wengue/Branco</p>
	<p>B60053M140</p>	<p>KIT GABINETE LOFT GAVETA E PORTA 60X38 COM CUBA DE APOIO Q6</p> <p>Wengue/Branco</p>







	<p>B60057M140</p>	<p>KIT GABINETE LOFT GAVETA E PORTA 60X38 COM CUBA DE APOIO R1</p> <p>Wengue/Branco</p>
	<p>B60061M140</p>	<p>KIT GABINETE LOFT GAVETA E PORTA 80X38 COM CUBA DE APOIO Q6</p> <p>Wengue/Branco</p>
	<p>B60045M140</p>	<p>KIT GABINETE LOFT 2 PORTAS 50X38 COM CUBA DE APOIO R1</p> <p>Wengue/Branco</p>

FIRST



IMAGEM	CÓDIGO	DESCRIÇÃO
		KIT GABINETE FIRST 1 PORTA E 3 GAVETAS 50X36, COM LAVATÓRIO E ESPELHO
	B60000M310	BRANCO
		KIT GABINETE FIRST 2 PORTAS E 1 GAVETA 50X36, COM LAVATÓRIO E ESPELHO
	B60003M310	BRANCO
		KIT GABINETE FIRST 1 PORTA E 3 GAVETAS 50X36, COM LAVATÓRIO E ESPELHO
	B60002M310	WENGE
		KIT GABINETE FIRST 2 PORTAS E 1 GAVETA 50X36, COM LAVATÓRIO E ESPELHO
	B60005M310	WENGE
		KIT GABINETE FIRST 1 PORTA E 3 GAVETAS 50X36, COM LAVATÓRIO E ESPELHO
	B60001M310	Branco/Wengue
		KIT GABINETE FIRST 2 PORTAS E 1 GAVETA 50X36, COM LAVATÓRIO E ESPELHO
	B60004M310	Branco/Wengue

AVANT

IMAGEM	CÓDIGO	DESCRIÇÃO
	B60015M240	KIT AVANT GABINETE 1 PORTA E 3 GAVETAS 60X34, COM ESPELHO E ESPELHO
		BRANCO
	B60012M240	KIT AVANT GABINETE 2 PORTAS E 1 GAVETA 60X34, COM LAVATÓRIO E ESPELHO
		BRANCO
	B60002M240	GABINETE AVANT 1 PORTA 41X34 COM ESPELHO
		Wengue Texturizado
	B60017M240	KIT AVANT GABINETE 1 PORTA E 3 GAVETAS 60X34, COM LAVATÓRIO E ESPELHO
		Wengue Texturizado
	B60014M240	KIT AVANT GABINETE 2 PORTAS E 1 GAVETA 60X34, COM LAVATÓRIO E ESPELHO
		Wengue Texturizado
	B60005M240	KIT GABINETE AVANT 1 PORTA E 1 GAVETA 41X34, COM LAVATÓRIO E ESPELHO
		Wengue Texturizado

		<p>KIT AVANT GABINETE 1 PORTA E 3 GAVETAS 60X34, COM LAVATÓRIO E ESPELHO</p>
	<p>B60016M240</p>	<p>WengueTX/Branco</p>
		<p>KIT AVANT GABINETE 2 PORTAS E 1 GAVETA 60X34, COM LAVATÓRIO E ESPELHO</p>
	<p>B60013M240</p>	<p>WengueTX/Branco</p>
		<p>KIT GABINETE AVANT 1 PORTA E 1 GAVETA 41X34, COM LAVATÓRIO E ESPELHO</p>
	<p>B60004M240</p>	<p>WengueTX/Branco</p>
		<p>KIT GABINETE AVANT 1 PORTA 41X34, COM LAVATÓRIO E ESPELHO</p>
	<p>B60001M240</p>	<p>WengueTX/Branco</p>
		<p>KIT GABINETE AVANT 1 PORTA E 1 GAVETA 41X34, COM LAVATÓRIO E ESPELHO</p>
	<p>B60003M240</p>	<p>BRANCO BRILHANTE</p>
		<p>KIT GABINETE AVANT 1 PORTA 41X34, COM LAVATÓRIO E ESPELHO</p>
	<p>B60000M240</p>	<p>BRANCO BRILHANTE</p>

ZIP

IMAGEM	CÓDIGO	DESCRIÇÃO
	B60000M250	KIT GABINETE ZIP 2 PORTAS 40X22, COM LAVATÓRIO E ESPELHO BRANCO
	B60001M250	KIT GABINETE ZIP 2 PORTAS 40X22, COM LAVATÓRIO E ESPELHO Branco/Wengue

GABINETE PARA TANQUE

IMAGEM	CÓDIGO	DESCRIÇÃO
		KIT TANQUE COM GABINETE 75X38X39 INCEPA
	B60001M370	BRANCO

FLEX

IMAGEM	CÓDIGO	DESCRIÇÃO
		ESPELHO COM BASE 54X58 FLEX
	B60004M170	SILVER
		ESPELHO COM BASE 65X58 FLEX
	B60005M170	SILVER
		ESPELHO COM BASE 80X58 FLEX
	B60006M170	SILVER

Processada em: 01/03/2021 07:58:22

Processada em: 01/03/2021 07:58:22

Louças

Incepa

PLATINUM

IMAGEM	CÓDIGO	DESCRIÇÃO
		CUBA APOIO QUADRADA SEM MESA 380X380 PLATINUM P5
	1450610017100	BRANCO
	1450610667100	CHAMPAGNE
	1450610107100	NOIR
	1450610147100	BRANCO MATTE
	1450610077100	GRIS
		CUBA APOIO REDONDO SEM MESA 390 PLATINIUM P2
	1450980017100	BRANCO
	1450980077100	GRIS
	1450980107100	NOIR
	1450980667100	CHAMPAGNE
	1450980887100	ROSE
	1450980147100	BRANCO MATTE
		CUBA DE APOIO COM DISPENSER 600X415 PLATINUM
	1450760011100	BRANCO
	1450760141100	BRANCO MATTE
		CUBA DE APOIO QUADRADA COM MESA 350X350 PLATINUM P4
	1450670019100	BRANCO
	1450670149100	BRANCO MATTE
	1450670079100	GRIS
	1450670109100	NOIR
	1450670889100	ROSE
		CUBA DE APOIO REDONDA SEM MESA 350 PLATINUM P1
	1450970017100	BRANCO
	1450970107100	NOIR
	1450970887100	ROSE
	1450970077100	GRIS
	1450970667100	CHAMPAGNE
	1450970147100	BRANCO MATTE

		CUBA DE APOIO REDONDA SEM MESA 425 PLATINUM P3
	1450990017100	BRANCO
	1450990667100	CHAMPAGNE
	1450990147100	BRANCO MATTE
	1450990107100	NOIR
	1450990077100	GRIS
		CUBA DE APOIO RETANGULAR COM MESA 450X420 PLATINUM P6
	1450730011100	BRANCO
	1450730661100	CHAMPAGNE
	1450730071100	GRIS
	1450730141100	BRANCO MATTE
	1450730881100	ROSE
	1450730101100	NOIR
		CUBA DE APOIO RETANGULAR COM MESA 600X415 PLATINUM P8
	1450750011100	BRANCO
	1450750881100	ROSE
	1450750661100	CHAMPAGNE
	1450750071100	GRIS
	1450750141100	BRANCO MATTE
	1450750101100	NOIR
		CUBA DE APOIO RETANGULAR SEM MESA 510X360 PLATINUM P7
	1450740017100	BRANCO
	1450740147100	BRANCO MATTE
	1450740667100	CHAMPAGNE
	1450740077100	GRIS
	1450740107100	NOIR

OCEAN

IMAGEM	CÓDIGO	DESCRIÇÃO
	1630670017100	CUBA APOIO 500X410 SEM MESA SEM LADRÃO PACIFIC
		BRANCO
	1632740017100	CUBA APOIO 650X410 SEM MESA SEM LADRÃO GRAN PACIFIC
		BRANCO
	1631740011100	CUBA APOIO 660X410 FURO CENTRAL SEM LADRÃO INDIAN
		BRANCO
	1630680011100	CUBA DE APOIO 400X400 FURO CENTRAL SEM LADRÃO PACIFIC
		BRANCO
	1630280011100	CUBA SEMIENCAIXE 400X400 FURO CENTRAL SEM LADRÃO PACIFIC
		BRANCO
	1630270017100	CUBA SEMIENCAIXE 490X400 SEM MESA SEM LADRÃO PACIFIC
		BRANCO



TOALHEIRO PARA CUBA SEMI-ENCAIXE
PACIFIC

3639030910100

CROMADO

LOFT

IMAGEM	CÓDIGO	DESCRIÇÃO
	1857250010100	KIT CUBA DE APOIO LOFT Q1, TORNEIRA BICA BAIXA NEW E COMPLEMENTOS DE INSTALAÇÃO
		BRANCO
	1857250011100	KIT CUBA DE APOIO LOFT Q6, TORNEIRA BICA BAIXA NEW E COMPLEMENTOS DE INSTALAÇÃO
		BRANCO
	1857250012100	KIT CUBA DE APOIO LOFT R1, TORNEIRA BICA ALTA NEW E COMPLEMENTOS DE INSTALAÇÃO
		BRANCO
	1220730013100	CUBA DE APOIO 430X420 COM MESA LOFT QR7
		BRANCO
	1140850013100	CUBA DE APOIO 450X400 COM MESA LOFT R6
		BRANCO
	1190490017100	CUBA APOIO 325X325 SEM MESA SEM LADRÃO LOFT Q9
		BRANCO

		CUBA APOIO 350X350 SEM MESA LOFT QR1
	1850690017100	BRANCO
		CUBA APOIO 410X410 COM MESA LOFT Q1
	1850670013100	BRANCO
	1850670073100	GRIS
	1850670143100	BRANCO MATTE
	1850670103100	NOIR
	1850670663100	CHAMPAGNE
		CUBA DE APOIO R0 300 DIAMETRO INCEPA
	1850990017100	BRANCO
		CUBA DE APOIO 350 DIAMETRO SEM MESA LOFT R1
	1850970017100	BRANCO
	1850970577100	BISCUIT
	1850970027100	PRETO
	1850970107100	NOIR
	1850970077100	GRIS
	1850970147100	BRANCO MATTE
	1850970667100	CHAMPAGNE
		CUBA DE APOIO 350X350 COM MESA LOFT Q6
	1850680013100	BRANCO
	1850680663100	CHAMPAGNE
	1850680143100	BRANCO MATTE
	1850680893100	CARRARA
	1850680573100	BISCUIT
	1850680073100	GRIS
	1850680103100	NOIR



		CUBA DE APOIO 350X350 SEM MESA LOFT Q5
	1850490017100	BRANCO
	1850490107100	NOIR
	1850490667100	CHAMPAGNE
	1850490077100	GRIS
	1850490147100	BRANCO MATTE
	1850490577100	BISCUIT
		CUBA DE APOIO 370 DIAMETRO SEM MESA LOFT R2
	1850980017100	BRANCO
		CUBA DE APOIO 420X420 VÁLVULA OCULTA COM MESA LOFT Q4
	1850610013100	BRANCO
	1850610073100	GRIS
	1850610143100	BRANCO MATTE
	1850610663100	CHAMPAGNE
	1850610103100	NOIR
		CUBA DE APOIO 440X265 COM MESA LOFT CURVE1
	1850740013100	BRANCO
		CUBA DE APOIO 450X280 SEM MESA LOFT QR3
	1850750017100	BRANCO
		CUBA DE APOIO 450X295 SEM MESA LOFT R3
	1850850017100	BRANCO

		CUBA DE SEMIENCAIXE 410X410 COM MESA LOFT Q2
	1850250013100	BRANCO
	1850250663100	CHAMPAGNE
	1850250073100	GRIS
	1850250103100	NOIR
	1850250143100	BRANCO MATTE
		CUBA SEMIENCAIXE VÁLVULA OCULTA COM MESA LOFT CURVE 5
	1850280013100	BRANCO
		CUBA DE SOBREPOR/EMBUTIR 410X410 SEM MESA LOFT Q3
	1850500017100	BRANCO
		CUBA DE SOBREPOR 420X420 COM MESA LOFT Q8
	1851330011100	BRANCO
		CUBA DE SOBREPOR 410X340 COM MESA LOFT Q7
	1850450013100	BRANCO

SERIE SENSAZIONI





IMAGEM	CÓDIGO	DESCRIÇÃO
	1770680013100	CUBA DE APOIO 455X400 COM MESA SENTIRE BRANCO
	1770760013100	CUBA DE APOIO 540X400 COM MESA PROVARE BRANCO
	1770270013100	CUBA SEMIENCAIXE 460X400 COM MESA SENTIRE BRANCO

SERIE DUE





IMAGEM	CÓDIGO	DESCRIÇÃO
	1400470017100	CUBA DE APOIO 505X355 SEM MESA SEM LADRÃO INVERNO
		BRANCO
	1400150017100	CUBA DE SOBREPOR 560X380 SEM MESA SEM LADRÃO OUTONO
		BRANCO

NEO

IMAGEM	CÓDIGO	DESCRIÇÃO
		KIT BACIA COM CAIXA, ASSENTO TERMOFIXO SOFT CLOSE E COMPLEMENTOS DE INSTALAÇÃO NEO
	1367230010100	BRANCO
	1367230140100	BRANCO MATTE
	1367230660100	CHAMPAGNE
	1367230880100	ROSE
	1367230100100	NOIR
	1367230070100	GRIS
		BACIA PARA CAIXA NEO RIMLESS
	1363640010100	BRANCO
		CAIXA ECOFLUSH 3/6 LITROS NEO ACTIVE CLEAN
	1365700015101	BRANCO
	1365700145101	BRANCO MATTE
	1365700105101	NOIR
	1365700665101	CHAMPAGNE
	1365700075101	GRIS
	1365700885101	ROSE
		CUBA DE APOIO 490X340 NEO
	1360850013100	BRANCO
		ASSENTO ORIGINAL TERMOFIXO SOFT CLOSE NEO
	3369830010100	BRANCO



 <p>FOTO MERAMENTE ILUSTRATIVA, CONSULTAR A COR DO PRODUTO NA DESCRIÇÃO.</p>	<p>3369830070100</p>	<p>ASSENTO ORIGINAL TERMOFIXO SOFT CLOSE NEO</p> <p>GRIS</p>
 <p>FOTO MERAMENTE ILUSTRATIVA, CONSULTAR A COR DO PRODUTO NA DESCRIÇÃO.</p>	<p>3369830100100</p>	<p>ASSENTO ORIGINAL TERMOFIXO SOFT CLOSE NEO</p> <p>NOIR</p>
 <p>FOTO MERAMENTE ILUSTRATIVA, CONSULTAR A COR DO PRODUTO NA DESCRIÇÃO.</p>	<p>3369830140100</p>	<p>ASSENTO ORIGINAL TERMOFIXO SOFT CLOSE NEO</p> <p>BRANCO MATTE</p>
 <p>FOTO MERAMENTE ILUSTRATIVA, CONSULTAR A COR DO PRODUTO NA DESCRIÇÃO.</p>	<p>3369830660100</p>	<p>ASSENTO ORIGINAL TERMOFIXO SOFT CLOSE NEO</p> <p>CHAMPAGNE</p>
 <p>FOTO MERAMENTE ILUSTRATIVA, CONSULTAR A COR DO PRODUTO NA DESCRIÇÃO.</p>	<p>3369830880100</p>	<p>ASSENTO ORIGINAL TERMOFIXO SOFT CLOSE NEO</p> <p>ROSE</p>

BOSS

IMAGEM	CÓDIGO	DESCRIÇÃO
		KIT BACIA COM CAIXA, ASSENTO TERMOFIXO SOFT CLOSE E COMPLEMENTOS DE INSTALAÇÃO BOSS
	1897230011100	BRANCO
	1897230661100	CHAMPAGNE
	1897230071100	GRIS
	1897230101100	NOIR
	1897230141100	BRANCO MATTE
	1897230881100	ROSE
		KIT BACIA CONVENCIONAL, ASSENTO TERMOFIXO SOFT CLOSE E COMPLEMENTOS DE INSTALAÇÃO BOSS
	1897270010100	BRANCO
		KIT BACIA CONVENCIONAL, ASSENTO PP SOFT CLOSE E COMPLEMENTOS DE INSTALAÇÃO BOSS
	1897270011100	BRANCO
	1897270660100	CHAMPAGNE
	1897270140100	BRANCO MATTE
	1897270100100	NOIR
	1897270070100	GRIS
	1897270880100	ROSE
		KIT BACIA COM CAIXA, ASSENTO PP SOFT CLOSE E COMPLEMENTOS DE INSTALAÇÃO BOSS
	1897230010100	BRANCO
		CONJUNTO BACIA PARA CAIXA E CAIXA 3/6 LITROS BOSS
	1897700011100	BRANCO

		BACIA PARA CAIXA BOSS
	1893510010100	BRANCO
	1893510880100	ROSE
	1893510070100	GRIS
	1893510660100	CHAMPAGNE
	1893510140100	BRANCO MATTE
	1893510100100	NOIR
		CAIXA ECOFLUSH 3/6 LITROS BOSS
	1895700015100	BRANCO
	1895700885100	ROSE
	1895700665100	CHAMPAGNE
	1895700145100	BRANCO MATTE
	1895700105100	NOIR
	1895700075100	GRIS
		BACIA CONVENCIONAL BOSS
	1893010010100	BRANCO
	1893010660100	CHAMPAGNE
	1893010100100	NOIR
	1893010140100	BRANCO MATTE
	1893010880100	ROSE
	1893010070100	GRIS
		CUBA DE APOIO 450X390 BOSS
	1890730011100	BRANCO
		CUBA DE SEMIENCAIXE 445X400 BOSS
	1890250011100	BRANCO
		LAVATÓRIO PARA COLUNA 457X390 BOSS
	1890010011100	BRANCO

		<p>COLUNA SUSPensa BOSS</p>
	<p>1892020010100</p>	<p>BRANCO</p>
		<p>ASSENTO ORIGINAL SOFT CLOSE POLIPROPILENO BOSS</p>
	<p>9899880010100</p>	<p>BRANCO</p>
		<p>ASSENTO ORIGINAL TERMOFIXO SOFT CLOSE BOSS</p>
	<p>3899830010100</p>	<p>BRANCO</p>
		<p>ASSENTO ORIGINAL TERMOFIXO SOFT CLOSE BOSS</p>
	<p>3899830070100</p>	<p>GRIS</p>
	<p>3899830100100</p>	<p>ASSENTO ORIGINAL TERMOFIXO SOFT CLOSE BOSS</p>
	<p>3899830140100</p>	<p>ASSENTO ORIGINAL TERMOFIXO SOFT CLOSE BOSS</p> <p>BRANCO MATTE</p>

		ASSENTO ORIGINAL TERMOFIXO SOFT CLOSE BOSS
	3899830660100	CHAMPAGNE
	3899830880100	ASSENTO ORIGINAL TERMOFIXO SOFT CLOSE BOSS
		ROSE

SUITE

IMAGEM	CÓDIGO	DESCRIÇÃO
	1377230010100	KIT BACIA COM CAIXA, ASSENTO PP SOFT CLOSE E COMPLEMENTOS DE INSTALAÇÃO SUITE
		BRANCO
	1377270010100	KIT BACIA CONVENCIONAL, ASSENTO PP SOFT CLOSE E COMPLEMENTOS DE INSTALAÇÃO SUITE
		BRANCO
	1377700010100	CONJUNTO BACIA PARA CAIXA E CAIXA 3/6 LITROS SUITE
		BRANCO
	1373510010100	BACIA PARA CAIXA SUITE
		BRANCO
	1375700015100	CAIXA ECOFLUSH 3/6 LITROS SUITE
		BRANCO
	1373010010100	BACIA CONVENCIONAL SUITE
		BRANCO

	<p>1370730012100</p>	<p>CUBA DE APOIO RETANGULAR 445X450 CENTÍMETROS COM MESA SUITE</p> <p>BRANCO</p>
	<p>1370010011100</p>	<p>LAVATÓRIO PARA COLUNA 450X370 SUITE</p> <p>BRANCO</p>
	<p>1370160011100</p>	<p>CUBA DE SOBREPOR 540X445 FURO CENTRAL SEM LADRÃO SUITE</p> <p>BRANCO</p>
	<p>1252020010100</p>	<p>COLUNA SUSPensa PARA LAVATÓRIO THEMA/SUITE</p> <p>BRANCO</p>
	<p>1252020570100</p>	<p>BISCUIT</p>
	<p>3379880010101</p>	<p>ASSENTO ORIGINAL SOFT CLOSE POLIPROPILENO SUITE</p> <p>BRANCO</p>

THEMA

IMAGEM	CÓDIGO	DESCRIÇÃO
		KIT BACIA COM CAIXA, ASSENTO PP SOFT CLOSE E COMPLEMENTOS DE INSTALAÇÃO THEMA
	1257230010100	BRANCO
	1257230510100	VERDE AGUA
	1257230480100	CINZA PLATINA
	1257230020100	PRETO
	1257230570100	BISCUIT
		KIT BACIA CONVENCIONAL, ASSENTO PP SOFT CLOSE E COMPLEMENTOS DE INSTALAÇÃO THEMA
	1257270010100	BRANCO
	1257270480100	CINZA PLATINA
	1257270510100	VERDE AGUA
	1257270570100	BISCUIT
	1257270020100	PRETO
		KIT CUBA DE APOIO THEMA, TORNEIRA BICA BAIXA NEW E COMPLEMENTOS DE INSTALAÇÃO
	1257250010100	BRANCO
		CONJUNTO BACIA E CAIXA 3/6 LITROS M THEMA
	1257700011100	BRANCO
	1257700021100	PRETO
	1257700571100	BISCUIT
		BACIA PARA CAIXA THEMA PLUS
	1253510010100	BRANCO
	1253510020100	PRETO
	1253510480100	CINZA PLATINA
	1253510510100	VERDE AGUA
	1253510570100	BISCUIT

		CAIXA M 3/6 LITROS AVANT/THEMA
	1555600015100	BRANCO
	1555600025100	PRETO
	1555600515100	VERDE AGUA
	1555600485100	CINZA PLATINA
	1555600575100	BISCUIT
		BACIA CONVENCIONAL THEMA PLUS
	1253010010100	BRANCO
	1253010480100	CINZA PLATINA
	1253010020100	PRETO
	1253010570100	BISCUIT
	1253010510100	VERDE AGUA
		BIDE 3 FUROS COM DUCHA COM LADRAO THEMA
	1254000010100	BRANCO
		CUBA DE APOIO 500X360 FURO CENTRAL SEM LADRÃO THEMA
	1250770011100	BRANCO
	1250770021100	PRETO
	1250770571100	BISCUIT
		LAVATÓRIO PARA COLUNA 525X425 FURO CENTRAL SEM LADRÃO THEMA
	1250060011100	BRANCO
	1250060511100	VERDE AGUA
	1250060021100	PRETO
	1250060571100	BISCUIT
	1250060481100	CINZA PLATINA
		COLUNA PARA LAVATÓRIO THEMA
	1252010010100	BRANCO
	1252010480100	CINZA PLATINA
	1252010510100	VERDE AGUA
	1252010570100	BISCUIT
	1252010020100	PRETO

		COLUNA SUSPensa PARA LAVATÓRIO THEMA/SUITE
	1252020010100	BRANCO
	1252020570100	BISCUIT
		ASSENTO ORIGINAL PP THEMA PLUS
	9259810011100	BRANCO
		ASSENTO ORIGINAL PP THEMA PLUS SOFT CLOSE
	9259880010100	BRANCO
		ASSENTO ORIGINAL TERMOFIXO SOFT CLOSE THEMA
	3259830010100	BRANCO
		ASSENTO ORIGINAL PP THEMA PLUS
	9259810021100	PRETO
		ASSENTO ORIGINAL PP THEMA PLUS SOFT CLOSE
	9259880020100	PRETO





	<p>9259810481100</p>	<p>ASSENTO ORIGINAL PP THEMA PLUS</p> <p>CINZA PLATINA</p>
	<p>9259880480100</p>	<p>ASSENTO ORIGINAL PP THEMA PLUS SOFT CLOSE</p> <p>CINZA PLATINA</p>
	<p>9259810511100</p>	<p>ASSENTO ORIGINAL PP THEMA PLUS</p> <p>VERDE AGUA</p>
	<p>9259880510100</p>	<p>ASSENTO ORIGINAL PP THEMA PLUS SOFT CLOSE</p> <p>VERDE AGUA</p>
	<p>9259810571100</p>	<p>ASSENTO ORIGINAL PP THEMA PLUS</p> <p>BISCUIT</p>
	<p>9259880570100</p>	<p>ASSENTO ORIGINAL PP THEMA PLUS SOFT CLOSE</p> <p>BISCUIT</p>

AVANT



IMAGEM	CÓDIGO	DESCRIÇÃO
	1177230011100	KIT BACIA COM CAIXA P, ASSENTO PP SOFT CLOSE E COMPLEMENTOS DE INSTALAÇÃO AVANT
		BRANCO
	1177270010100	KIT BACIA CONVENCIONAL, ASSENTO PP SOFT CLOSE E COMPLEMENTOS DE INSTALAÇÃO AVANT
		BRANCO
	1177730012100	CONJUNTO BACIA PARA CAIXA E CAIXA 3/6 LTS P AVANT
		BRANCO
	1173510010100	BACIA PARA CAIXA AVANT PLUS
		BRANCO
	1505600015100	CAIXA ECOFLUSH 3/6 LITROS ART/FIRST /AVANT
		BRANCO
	1505600575100	BISCUIT
	1173010010100	BACIA CONVENCIONAL AVANT PLUS
		BRANCO

		<p>LAVATÓRIO PARA COLUNA 495X410 AVANT PLUS</p>
	<p>1170010011100</p>	<p>BRANCO</p>
		<p>COLUNA PARA LAVATÓRIO AVANT PLUS</p>
	<p>1172010010100</p>	<p>BRANCO</p>
		<p>COLUNA SUSPENSO PARA LAVATÓRIO AVANT PLUS</p>
	<p>1172020010100</p>	<p>BRANCO</p>
		<p>ASSENTO ORIGINAL SOFTCLOSE POLIPROPILENO PLUS AVANT/ART</p>
	<p>9179880011100</p>	<p>BRANCO</p>

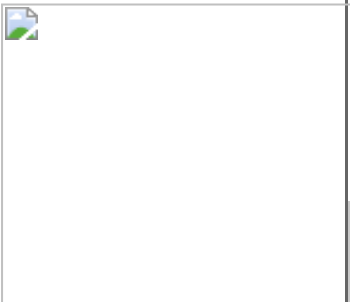
ART

IMAGEM	CÓDIGO	DESCRIÇÃO
	1507230010100	KIT BACIA COM CAIXA, ASSENTO PP E COMPLEMENTOS DE INSTALAÇÃO ART
	1507230570100	BRANCO
	1507700011100	CONJUNTO BACIA E CAIXA 3/6 LITROS ART
	1507700571100	BRANCO
	1507700010100	CONJUNTO BACIA E CAIXA 6 LITROS ART
	1507700570100	BRANCO
	1503550010100	BACIA PARA CAIXA ART
	1503550570100	BRANCO
	1505600015100	CAIXA ECOFLUSH 3/6 LITROS ART/FIRST /AVANT
	1505600575100	BRANCO
	1505100015100	CAIXA PARA ACOPLAR ACIONAMENTO LATERAL ART/ACESSO - NORMA ABNT 9050
		BRANCO

		CAIXA PARA ACOPLAR 6 LITROS ART
	1505600013100	BRANCO
	1505600573100	BISCUIT
		BACIA CONVENCIONAL ART
	1503050010100	BRANCO
	1503050570100	BISCUIT
		LAVATÓRIO PARA COLUNA 495X410 FURO CENTRAL SEM LADRÃO ART
	1500010011100	BRANCO
	1500010571100	BISCUIT
		COLUNA PARA LAVATÓRIO ART
	1502010010100	BRANCO
	1502010570100	BISCUIT
		COLUNA SUSPensa PARA LAVATÓRIO ART
	1502020010100	BRANCO
	1502020570100	BISCUIT
		ASSENTO ORIGINAL POLIPROPILENO LIKE/ART
	9509810010100	BRANCO

		ASSENTO ORIGINAL SOFTCLOSE POLIPROPILENO PLUS AVANT/ART
	9179880011100	BRANCO
		ASSENTO ORIGINAL POLIPROPILENO LIKE/ART
	9509810590100	PERGAMON

FIRST





IMAGEM	CÓDIGO	DESCRIÇÃO
		KIT BACIA COM CAIXA, ASSENTO PP E COMPLEMENTOS DE INSTALAÇÃO FIRST
	1937230010100	BRANCO
		CONJUNTO BACIA COM CAIXA, CAIXA 3/6 LITROS ECOFLUSH FIRST
	1937700010100	BRANCO
		BACIA PARA CAIXA FIRST RIMLESS
	1933640010100	BRANCO
		CAIXA ECOFLUSH 3/6 LITROS ART/FIRST /AVANT
	1505600015100	BRANCO
	1505600575100	BISCUIT
		LAVATÓRIO APOIO/SUSPENSO 400X300 FIRST
	1930360011100	BRANCO
		ASSENTO ORIGINAL POLIPROPILENO NET/FIRST
	9929810010300	BRANCO

FLAMINGO

IMAGEM	CÓDIGO	DESCRIÇÃO
	1117230010100	KIT BACIA COM CAIXA, ASSENTO PP SOFT CLOSE E COMPLEMENTOS DE INSTALAÇÃO FLAMINGO BRANCO
	1117270010100	KIT BACIA CONVENCIONAL, ASSENTO PP SOFT CLOSE E COMPLEMENTOS DE INSTALAÇÃO FLAMINGO BRANCO
	1117700012100	CONJUNTO BACIA COM SAÍDA HORIZONTAL E CAIXA P 3/6 LITROS FLAMINGO BRANCO
	1117700021100	PRETO
	1117700571100	BISCUIT
	1117700481100	CINZA PLATINA
	1117700011100	CONJUNTO BACIA PARA CAIXA E CAIXA P 3/6 LITROS FLAMINGO BRANCO
	1117700481100	CINZA PLATINA
	1117700571100	BISCUIT
	1117700021100	PRETO
	1117310010100	CONJUNTO BACIA CONVENCIONAL, LAVATÓRIO COM COLUNA FLAMINGO PLUS BRANCO
	1117310570100	BISCUIT
	1117310480100	CINZA PLATINA
	1113510010100	BACIA PARA CAIXA FLAMINGO PLUS BRANCO
	1113510020100	PRETO
	1113510570100	BISCUIT
	1113510480100	CINZA PLATINA

		BACIA PARA CAIXA 3/6 LITROS SAIDA HORIZONTAL FLAMINGO
	1113570011100	BRANCO
		CAIXA P 3/6 LITROS FLAMINGO/ACESSO/ZIP
	1555700015100	BRANCO
	1555700485100	CINZA PLATINA
	1555700025100	PRETO
	1555700575100	BISCUIT
		BACIA CONVENCIONAL FLAMINGO PLUS
	1113010010100	BRANCO
	1113010480100	CINZA PLATINA
	1113010020100	PRETO
	1113010570100	BISCUIT
		LAVATÓRIO PARA COLUNA 470X385 FURO CENTRAL SEM LADRÃO FLAMINGO
	1110070011100	BRANCO
	1110070481100	CINZA PLATINA
	1110070571100	BISCUIT
		LAVATÓRIO SUSPENSO 430X325 FURO APONTADO COM LADRÃO FLAMINGO
	1110380012100	BRANCO
	1110380022100	PRETO
		COLUNA PARA LAVÁTORIO FLAMINGO
	1112000010100	BRANCO
	1112000480100	CINZA PLATINA
	1112000570100	BISCUIT

	<p>3909860010100</p>	<p>ASSENTO ORIGINAL CONFORT PLUS</p> <p>BRANCO</p>
	<p>3909840010100</p>	<p>ASSENTO ORIGINAL CONFORT SOPRADO</p> <p>BRANCO</p>
	<p>9909810010300</p>	<p>ASSENTO ORIGINAL POLIPROPILENO ECO UNIVERSAL</p> <p>BRANCO</p>
	<p>9909810020300</p>	<p>ASSENTO ORIGINAL POLIPROPILENO ECO UNIVERSAL</p> <p>PRETO</p>
	<p>9909810030300</p>	<p>ASSENTO ORIGINAL POLIPROPILENO ECO UNIVERSAL</p> <p>CINZA</p>
	<p>9909810480300</p>	<p>ASSENTO ORIGINAL POLIPROPILENO ECO UNIVERSAL</p> <p>CINZA PLATINA</p>





	<p>9909810500300</p>	<p>ASSENTO ORIGINAL POLIPROPILENO ECO UNIVERSAL</p> <p>OCRE</p>
	<p>9909810570300</p>	<p>ASSENTO ORIGINAL POLIPROPILENO ECO UNIVERSAL</p> <p>BISCUIT</p>
	<p>9909810580300</p>	<p>ASSENTO ORIGINAL POLIPROPILENO ECO UNIVERSAL</p> <p>BEGE AREIA</p>
	<p>9909810590300</p>	<p>ASSENTO ORIGINAL POLIPROPILENO ECO UNIVERSAL</p> <p>PERGAMON</p>
	<p>9909810770300</p>	<p>ASSENTO ORIGINAL POLIPROPILENO ECO UNIVERSAL</p> <p>CINZA PRATA</p>

ZIP

IMAGEM	CÓDIGO	DESCRIÇÃO
		COMBO BACIA COM CAIXA P 3/6 LITROS E ASSENTO ECO ZIP
	1467920017100	BRANCO
	1467920577100	BISCUIT
	1467920487100	CINZA PLATINA
		COMBO BACIA COM CAIXA P 6 LITROS E ASSENTO ECO ZIP
	1467920016100	BRANCO
	1467920576100	BISCUIT
	1467920486100	CINZA PLATINA
		CONJUNTO BACIA COM CAIXA 3/6 LITROS P, ZIP
	1467700013100	BRANCO
	1467700483100	CINZA PLATINA
	1467700573100	BISCUIT
		CONJUNTO BACIA COM CAIXA 6 LITROS P, ZIP
	1467700012100	BRANCO
	1467700482100	CINZA PLATINA
	1467700572100	BISCUIT
		COMBO BACIA CONVENCIONAL E ASSENTO PP ECO ZIP
	1467780013100	BRANCO
	1467780573100	BISCUIT
	1467780483100	CINZA PLATINA
		CONJUNTO BACIA CONVENCIONAL E LAVATÓRIO COM COLUNA ZIP
	1467310010100	BRANCO
	1467310570100	BISCUIT
	1467310480100	CINZA PLATINA

		BACIA PARA CAIXA ZIP
	1463530010100	BRANCO
	1463530480100	CINZA PLATINA
	1463530570100	BISCUIT
		CAIXA P 3/6 LITROS FLAMINGO/ACESSO/ZIP
	1555700015100	BRANCO
	1555700575100	BISCUIT
	1555700485100	CINZA PLATINA
		CAIXA P 6 LITROS ZIP
	1555700012100	BRANCO
	1555700482100	CINZA PLATINA
	1555700572100	BISCUIT
		BACIA CONVENCIONAL ZIP
	1463030010100	BRANCO
	1463030570100	BISCUIT
	1463030480100	CINZA PLATINA
		LAVATÓRIO PARA COLUNA 470X425 FURO CENTRAL SEM LADRÃO ZIP
	1460070011100	BRANCO
	1460070571100	BISCUIT
	1460070481100	CINZA PLATINA
		COLUNA PARA LAVÁTORIO ZIP
	1462010010100	BRANCO
	1462010480100	CINZA PLATINA
	1462010570100	BISCUIT





	<p>3909860010100</p>	<p>ASSENTO ORIGINAL CONFORT PLUS</p> <p>BRANCO</p>
	<p>3909840010100</p>	<p>ASSENTO ORIGINAL CONFORT SOPRADO</p> <p>BRANCO</p>
	<p>9909810010300</p>	<p>ASSENTO ORIGINAL POLIPROPILENO ECO UNIVERSAL</p> <p>BRANCO</p>
	<p>9909810020300</p>	<p>ASSENTO ORIGINAL POLIPROPILENO ECO UNIVERSAL</p> <p>PRETO</p>
	<p>9909810030300</p>	<p>ASSENTO ORIGINAL POLIPROPILENO ECO UNIVERSAL</p> <p>CINZA</p>
	<p>9909810480300</p>	<p>ASSENTO ORIGINAL POLIPROPILENO ECO UNIVERSAL</p> <p>CINZA PLATINA</p>

		<p>ASSENTO ORIGINAL POLIPROPILENO ECO UNIVERSAL</p>
	<p>9909810500300</p>	<p>OCRE</p>
		<p>ASSENTO ORIGINAL POLIPROPILENO ECO UNIVERSAL</p>
	<p>9909810570300</p>	<p>BISCUIT</p>
		<p>ASSENTO ORIGINAL POLIPROPILENO ECO UNIVERSAL</p>
	<p>9909810580300</p>	<p>BEGE AREIA</p>
		<p>ASSENTO ORIGINAL POLIPROPILENO ECO UNIVERSAL</p>
	<p>9909810590300</p>	<p>PERGAMON</p>
		<p>ASSENTO ORIGINAL POLIPROPILENO ECO UNIVERSAL</p>
	<p>9909810770300</p>	<p>CINZA PRATA</p>

CUBAS

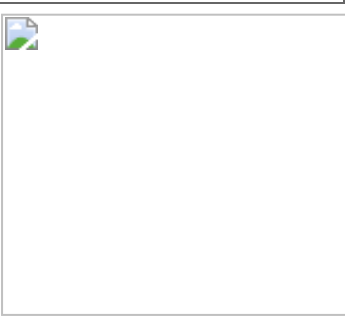
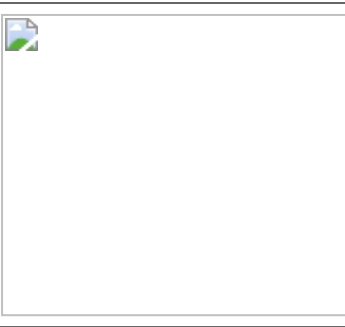
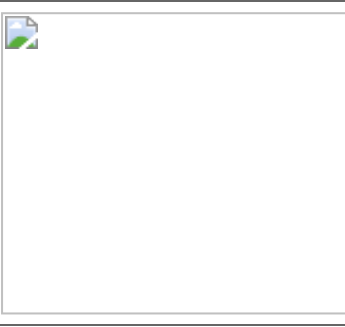

IMAGEM	CÓDIGO	DESCRIÇÃO
		CUBA DE SOBREPOR OVAL 520X445 FURO CENTRAL SEM LADRÃO INCEPA
	1761460011100	BRANCO
		CUBA EMBUTIR OVAL 490X325 SEM MESA SEM LADRÃO INCEPA
	1761170017100	BRANCO
	1761170027100	PRETO
	1761170577100	BISCUIT
		CUBA EMBUTIR RETANGULAR 505X370 SEM MESA SEM LADRÃO
	1761070017100	BRANCO

ACESSO

IMAGEM	CÓDIGO	DESCRIÇÃO
	1317230012100	KIT BACIA COM CAIXA ACIONAMENTO LATERAL, ASSENTO PP COM ABERTURA E COMPLEMENTOS DE INSTALAÇÃO ACESSO INCEPA
	1317230010100	KIT BACIA COM CAIXA, ASSENTO PP COM ABERTURA E COMPLEMENTOS DE INSTALAÇÃO ACESSO INCEPA
	1317230013100	KIT BACIA COM CAIXA ACIONAMENTO LATERAL, ASSENTO PP SOFT CLOSE E COMPLEMENTOS DE INSTALAÇÃO ACESSO CONFORT INCEPA
	1317230011100	KIT BACIA COM CAIXA, ASSENTO PP SOFT CLOSE E COMPLEMENTOS DE INSTALAÇÃO ACESSO CONFORT INCEPA
	1317270010100	BACIA CONVENCIONAL COM ABERTURA, COMPLEMENTOS DE INSTALAÇÃO E ASSENTO POLIPROPILENO ACESSO INCEPA
	1317270011100	BACIA CONVENCIONAL SEM ABERTURA, COM COMPLEMENTOS DE INSTALAÇÃO ASSENTO POLIPROPILENO ACESSO CONFORT INCEPA



	<p>1317700013100</p>	<p>CONJUNTO BACIA COM ABERTURA FRONTAL, CAIXA 3/6 LITROS P, ACESSO INCEPA</p> <p>BRANCO</p>
	<p>1317700012100</p>	<p>CONJUNTO BACIA SEM ABERTURA FRONTAL COM CAIXA 3/6 P, ACESSO CONFORT INCEPA BRANCO</p> <p>BRANCO</p>
	<p>1317310010100</p>	<p>CONJUNTO BACIA CONVENCIONAL COM ABERTURA E LAVATÓRIO COM COLUNA ACESSO INCEPA</p> <p>BRANCO</p>
	<p>1317310011100</p>	<p>CONJUNTO BACIA CONVENCIONAL SEM ABERTURA E LAVATÓRIO COM COLUNA ACESSO CONFORT</p> <p>BRANCO</p>
	<p>1313590010100</p>	<p>BACIA PARA CAIXA COM ABERTURA FRONTAL ACESSO INCEPA</p> <p>BRANCO</p>
	<p>1313600010100</p>	<p>BACIA PARA CAIXA SEM ABERTURA FRONTAL ACESSO INCEPA - NORMA ABNT9050</p> <p>BRANCO</p>

		CAIXA P 3/6 LITROS FLAMINGO/ACESSO/ZIP
	1555700015100	BRANCO
	1555700485100	CINZA PLATINA
	1555700575100	BISCUIT
	1555700025100	PRETO
		BACIA CONVENCIONAL ACESSO INCEPA
	1313090010100	BRANCO
		BACIA CONVENCIONAL SEM ABERTURA FRONTAL ACESSO INCEPA - NORMA ABNT9050
	1313100010100	BRANCO
		LAVATÓRIO PARA COLUNA 600X415 COM MESA ACESSO PLUS
	1310550011100	BRANCO
		COLUNA SUSPensa PARA LAVATÓRIO ACESSO PLUS
	1312020010100	BRANCO
		ASSENTO ORIGINAL POLIPROPILENO ACESSO PLUS
	3319810010100	BRANCO

		ASSENTO ORIGINAL CONFORT PLUS
	3909860010100	BRANCO
		ASSENTO ORIGINAL CONFORT SOPRADO
	3909840010100	BRANCO

ACESSO CONFORT

IMAGEM	CÓDIGO	DESCRIÇÃO
	1317230013100	KIT BACIA COM CAIXA ACIONAMENTO LATERAL, ASSENTO PP SOFT CLOSE E COMPLEMENTOS DE INSTALAÇÃO ACESSO CONFORT INCEPA
		BRANCO
	1317230011100	KIT BACIA COM CAIXA, ASSENTO PP SOFT CLOSE E COMPLEMENTOS DE INSTALAÇÃO ACESSO CONFORT INCEPA
		BRANCO
	1317270011100	BACIA CONVENCIONAL SEM ABERTURA, COM COMPLEMENTOS DE INSTALAÇÃO ASSENTO POLIPROPILENO ACESSO CONFORT INCEPA
		BRANCO
	1317700012100	CONJUNTO BACIA SEM ABERTURA FRONTAL COM CAIXA 3/6 P, ACESSO CONFORT INCEPA
		BRANCO
	1317310011100	CONJUNTO BACIA CONVENCIONAL SEM ABERTURA E LAVATÓRIO COM COLUNA ACESSO CONFORT
		BRANCO
	1313600010100	BACIA PARA CAIXA SEM ABERTURA FRONTAL ACESSO INCEPA - NORMA ABNT9050
		BRANCO

		CAIXA P 3/6 LITROS FLAMINGO/ACESSO/ZIP
	1555700015100	BRANCO
	1555700575100	BISCUIT
	1555700025100	PRETO
	1555700485100	CINZA PLATINA
		BACIA CONVENCIONAL SEM ABERTURA FRONTAL ACESSO INCEPA - NORMA ABNT9050
	1313100010100	BRANCO

KIDS

IMAGEM	CÓDIGO	DESCRIÇÃO
	1087230010100	KIT BACIA COM CAIXA, ASSENTO PP E COMPLEMENTOS DE INSTALAÇÃO INCEPA KIDS
		BRANCO
	1087270010100	BACIA CONVENCIONAL COM COMPLEMENTOS DE INSTALAÇÃO ASSENTO POLIPROPILENO KIDS
		BRANCO
	1087690011100	CONJUNTO BACIA PARA CAIXA, CAIXA PARA ACOPLAR ECOFLUSH 3/6 LITROS KIDS
		BRANCO
	1082540010100	BACIA CONVENCIONAL 6,8 LITROS INCEPA INFANTIL
		BRANCO
	1082550010100	BACIA PARA CAIXA INFANTIL
		BRANCO
	1085700015100	CAIXA ECOFLUSH 3/6 LITROS ACIONAMENTO NA TAMPA INFANTIL
		BRANCO



ASSENTO ORIGINAL POLIPROPILENO BACIA
INFANTIL







3089810010100





BRANCO

LAVATÓRIOS

IMAGEM	CÓDIGO	DESCRIÇÃO
	1330390013100	LAVATÓRIO SUSPENSO P 380X280 FURO APONTADO SEM LADRÃO INCEPA BRANCO
	1270370013100	LAVATÓRIO SUSPENSO M 465X340 FURO APONTADO SEM LADRÃO INCEPA BRANCO
	1040360011100	LAVATÓRIO APOIO/SUSPENSO 400X300 INCEPA BRANCO
	1040130011100	LAVATÓRIO SUSPENSO CANTO M 41X32X23 FURO CENTRAL SEM LADRÃO INCEPA BRANCO
	1040140011100	LAVATÓRIO SUSPENSO CANTO P 420X345X300 INCEPA BRANCO

CUBAS

IMAGEM	CÓDIGO	DESCRIÇÃO
		CUBA DE SOBREPOR OVAL 435X310 SEM MESA SEM LADRÃO INCEPA
	1101480017100	BRANCO
	1101480577100	BISCUIT
		CUBA DE SOBREPOR/EMBUTIR OVAL 430X310 INCEPA
	1101450017100	BRANCO
		CUBA DE SOBREPOR/EMBUTIR RETANGULAR 390X310 INCEPA
	1101350017100	BRANCO
		CUBA SOBREPOR RETANGULAR 450X430 INCEPA BRANCO
	1101380011101	BRANCO
		CUBA SOBREPOR/EMBUTIR REDONDA 310 DIAMETRO INCEPA
	1101510017100	BRANCO
	1101510577100	BISCUIT
		CUBA SOBREPOR/EMBUTIR REDONDA 360 DIAMETRO INCEPA
	1101600017100	BRANCO
	1101600517100	VERDE AGUA

	<p>1101360010100</p>	<p>CUBA SOEBOR RETANGULAR 520X460 FURO CENTRAL COM LADRÃO INCEPA</p> <p>BRANCO</p>
	<p>1101190017100 1101190577100 1101190487100 1101190027100</p>	<p>CUBA EMBUTIR OVAL 390X300 SEM MESA SEM LADRÃO INCEPA</p> <p>BRANCO BISCUIT CINZA PLATINA PRETO</p>
	<p>1101160016100</p>	<p>CUBA EMBUTIR OVAL 510X350 SEM MESA COM LADRÃO INCEPA</p> <p>BRANCO</p>
	<p>1101290017100 1101290577100</p>	<p>CUBA EMBUTIR REDONDA 365 DIAMENTRO SEM MESA SEM LADRÃO INCEPA</p> <p>BRANCO BISCUIT</p>

TANQUES

IMAGEM	CÓDIGO	DESCRIÇÃO
		TANQUE G BUILDERS 590X520 FURO APONTADO SEM LADRAO
	1512640013100	BRANCO
		TANQUE G 600X520 COM MESA INCEPA
	1512660013100	BRANCO
		TANQUE GG 655X565 SEM FURO SEM LADRÃO INCEPA
	1512620017100	BRANCO
		TANQUE M BUILDERS 545X485, FURO APONTADO SEM LADRÃO BRANCO
	1512680013100	BRANCO
		TANQUE M 545X485 SEM MESA INCEPA
	1512650013100	BRANCO
		TANQUE P FURO APONTADO SEM LADRÃO INCEPA
	1512630013100	BRANCO



TANQUE PP FURO APONTADO SEM LADRAO
INCEPA

1512670013100

BRANCO





COLUNA PARA TANQUE INCEPA

1512030010100

BRANCO

PRO

IMAGEM	CÓDIGO	DESCRIÇÃO
		KIT MICTORIO ECO COM VALVULA E COMPLEMENTOS DE INSTALAÇÃO
	1087240010100	BRANCO
		MICTORIO COM SIFAO ECO INCEPA
	1082850010100	BRANCO







Processada em: 01/03/2021 07:58:22

Processada em: 01/03/2021 07:58:22

Assentos

Incepa

NEO

IMAGEM	CÓDIGO	DESCRIÇÃO
		ASSENTO ORIGINAL TERMOFIXO SOFT CLOSE NEO
	3369830010100	BRANCO
 <small>FOTO MERAMENTE ILUSTRATIVA, CONSULTAR A COR DO PRODUTO NA DESCRIÇÃO.</small>		ASSENTO ORIGINAL TERMOFIXO SOFT CLOSE NEO
	3369830070100	GRIS
 <small>FOTO MERAMENTE ILUSTRATIVA, CONSULTAR A COR DO PRODUTO NA DESCRIÇÃO.</small>		ASSENTO ORIGINAL TERMOFIXO SOFT CLOSE NEO
	3369830100100	NOIR
 <small>FOTO MERAMENTE ILUSTRATIVA, CONSULTAR A COR DO PRODUTO NA DESCRIÇÃO.</small>		ASSENTO ORIGINAL TERMOFIXO SOFT CLOSE NEO
	3369830140100	BRANCO MATTE
 <small>FOTO MERAMENTE ILUSTRATIVA, CONSULTAR A COR DO PRODUTO NA DESCRIÇÃO.</small>		ASSENTO ORIGINAL TERMOFIXO SOFT CLOSE NEO
	3369830660100	CHAMPAGNE
		ASSENTO ORIGINAL TERMOFIXO SOFT CLOSE NEO
	3369830880100	ROSE

BOSS

IMAGEM	CÓDIGO	DESCRIÇÃO
		ASSENTO ORIGINAL SOFT CLOSE POLIPROPILENO BOSS
	9899880010100	BRANCO
		ASSENTO ORIGINAL TERMOFIXO SOFT CLOSE BOSS
	3899830010100	BRANCO
		ASSENTO ORIGINAL TERMOFIXO SOFT CLOSE BOSS
	3899830070100	GRIS
		ASSENTO ORIGINAL TERMOFIXO SOFT CLOSE BOSS
	3899830100100	NOIR
		ASSENTO ORIGINAL TERMOFIXO SOFT CLOSE BOSS
	3899830140100	BRANCO MATTE
		ASSENTO ORIGINAL TERMOFIXO SOFT CLOSE BOSS
	3899830660100	CHAMPAGNE



ASSENTO ORIGINAL TERMOFIXO SOFT CLOSE
BOSS

3899830880100

ROSE

SUITE

IMAGEM	CÓDIGO	DESCRIÇÃO
	3379880010101	ASSENTO ORIGINAL SOFT CLOSE POLIPROPILENO SUITE BRANCO

THEMA

IMAGEM	CÓDIGO	DESCRIÇÃO
		ASSENTO ORIGINAL PP THEMA PLUS
	9259810011100	BRANCO
		ASSENTO ORIGINAL PP THEMA PLUS SOFT CLOSE
	9259880010100	BRANCO
		ASSENTO ORIGINAL TERMOFIXO SOFT CLOSE THEMA
	3259830010100	BRANCO
		ASSENTO ORIGINAL PP THEMA PLUS
	9259810021100	PRETO
		ASSENTO ORIGINAL PP THEMA PLUS SOFT CLOSE
	9259880020100	PRETO
		ASSENTO ORIGINAL PP THEMA PLUS
	9259810481100	CINZA PLATINA

	<p>9259880480100</p>	<p>ASSENTO ORIGINAL PP THEMA PLUS SOFT CLOSE</p> <p>CINZA PLATINA</p>
	<p>9259810511100</p>	<p>ASSENTO ORIGINAL PP THEMA PLUS</p> <p>VERDE AGUA</p>
	<p>9259880510100</p>	<p>ASSENTO ORIGINAL PP THEMA PLUS SOFT CLOSE</p> <p>VERDE AGUA</p>
	<p>9259810571100</p>	<p>ASSENTO ORIGINAL PP THEMA PLUS</p> <p>BISCUIT</p>
	<p>9259880570100</p>	<p>ASSENTO ORIGINAL PP THEMA PLUS SOFT CLOSE</p> <p>BISCUIT</p>

AVANT

IMAGEM	CÓDIGO	DESCRIÇÃO
		ASSENTO ORIGINAL SOFTCLOSE POLIPROPILENO PLUS AVANT/ART
	9179880011100	BRANCO







ART

IMAGEM	CÓDIGO	DESCRIÇÃO
	9509810010100	ASSENTO ORIGINAL POLIPROPILENO LIKE/ART BRANCO
	9179880011100	ASSENTO ORIGINAL SOFTCLOSE POLIPROPILENO PLUS AVANT/ART BRANCO
	9509810590100	ASSENTO ORIGINAL POLIPROPILENO LIKE/ART PERGAMON

FIRST

IMAGEM	CÓDIGO	DESCRIÇÃO
	9929810010300	ASSENTO ORIGINAL POLIPROPILENO NET/FIRST BRANCO

FLAMINGO

IMAGEM	CÓDIGO	DESCRIÇÃO
		ASSENTO ORIGINAL CONFORT PLUS
	3909860010100	BRANCO
		ASSENTO ORIGINAL CONFORT SOPRADO
	3909840010100	BRANCO
		ASSENTO ORIGINAL POLIPROPILENO ECO UNIVERSAL
	9909810010300	BRANCO
		ASSENTO ORIGINAL POLIPROPILENO ECO UNIVERSAL
	9909810020300	PRETO
		ASSENTO ORIGINAL POLIPROPILENO ECO UNIVERSAL
	9909810030300	CINZA
		ASSENTO ORIGINAL POLIPROPILENO ECO UNIVERSAL
	9909810480300	CINZA PLATINA

















	<p>9909810500300</p>	<p>ASSENTO ORIGINAL POLIPROPILENO ECO UNIVERSAL</p> <p>OCRE</p>
	<p>9909810570300</p>	<p>ASSENTO ORIGINAL POLIPROPILENO ECO UNIVERSAL</p> <p>BISCUIT</p>
	<p>9909810580300</p>	<p>ASSENTO ORIGINAL POLIPROPILENO ECO UNIVERSAL</p> <p>BEGE AREIA</p>
	<p>9909810590300</p>	<p>ASSENTO ORIGINAL POLIPROPILENO ECO UNIVERSAL</p> <p>PERGAMON</p>
	<p>9909810770300</p>	<p>ASSENTO ORIGINAL POLIPROPILENO ECO UNIVERSAL</p> <p>CINZA PRATA</p>

IMAGEM	CÓDIGO	DESCRIÇÃO
		ASSENTO ORIGINAL CONFORT PLUS
	3909860010100	BRANCO
		ASSENTO ORIGINAL CONFORT SOPRADO
	3909840010100	BRANCO
		ASSENTO ORIGINAL POLIPROPILENO ECO UNIVERSAL
	9909810010300	BRANCO
		ASSENTO ORIGINAL POLIPROPILENO ECO UNIVERSAL
	9909810020300	PRETO
		ASSENTO ORIGINAL POLIPROPILENO ECO UNIVERSAL
	9909810030300	CINZA
		ASSENTO ORIGINAL POLIPROPILENO ECO UNIVERSAL
	9909810480300	CINZA PLATINA

		<p>ASSENTO ORIGINAL POLIPROPILENO ECO UNIVERSAL</p>
	<p>9909810500300</p>	<p>OCRE</p>
		<p>ASSENTO ORIGINAL POLIPROPILENO ECO UNIVERSAL</p>
	<p>9909810570300</p>	<p>BISCUIT</p>
		<p>ASSENTO ORIGINAL POLIPROPILENO ECO UNIVERSAL</p>
	<p>9909810580300</p>	<p>BEGE AREIA</p>
		<p>ASSENTO ORIGINAL POLIPROPILENO ECO UNIVERSAL</p>
	<p>9909810590300</p>	<p>PERGAMON</p>
		<p>ASSENTO ORIGINAL POLIPROPILENO ECO UNIVERSAL</p>
	<p>9909810770300</p>	<p>CINZA PRATA</p>

ACESSO

IMAGEM	CÓDIGO	DESCRIÇÃO
		ASSENTO ORIGINAL CONFORT PLUS
	3909860010100	BRANCO
		ASSENTO ORIGINAL CONFORT SOPRADO
	3909840010100	BRANCO
		ASSENTO ORIGINAL POLIPROPILENO ACESSO PLUS
	3319810010100	BRANCO

KIDS

IMAGEM	CÓDIGO	DESCRIÇÃO
	3089810010100	ASSENTO ORIGINAL POLIPROPILENO BACIA INFANTIL BRANCO

Processada em: 01/03/2021 07:58:22







Processada em: 01/03/2021 07:58:22

Complementos e reposição



REPAROS

IMAGEM	CÓDIGO	DESCRIÇÃO
 <p>ANEL DE VEDAÇÃO Incepa Celite logosa COM GUIA</p>		ANEL DE VEDAÇÃO COM GUIA PARA BACIA SANITARIA
	3009510010100	SEM COR
		BOTAO ACIONAMENTO LATERAL 6L CROMADO
	BL00041CRR	SEM COR
		ESPUDE BITOLA 5
	BL0004300R	SEM COR
		KIT MECANISMO 6 LITROS ACIONAMENTO SUPERIOR
	1969110013100	SEM COR
 <p>Roca EMI MECANISMO UNIVERSAL TOUCHLESS</p>		MECANISMO DUPLO ACIONAMENTO TOUCHLESS ROCA
	BL00233PRR	SEM COR
		MECANISMO UNIVERSAL DUPLO ACIONAMENTO
	3969110001100	SEM COR



	<p>1969110005100</p>	<p>REPOSIÇÃO BOTÃO DE ACIONAMENTO 48 MILIMETROS 6 LITROS</p> <p>SEM COR</p>
	<p>1969110002100</p>	<p>REPOSIÇÃO BOTÃO DE ACIONAMENTO 98 MILIMETROS 3/6 LITROS</p> <p>SEM COR</p>
	<p>1969110003100</p>	<p>REPOSIÇÃO GASKET CONICO E FIXAÇÃO</p> <p>SEM COR</p>
	<p>1969110007100</p>	<p>REPOSIÇÃO KIT MECANISMO 3/6 LITROS</p> <p>SEM COR</p>
	<p>1969110000100</p>	<p>REPOSICAO MECANISMO DE ENTRADA D'AGUA PARA CAIXA DE DESCARGA</p> <p>SEM COR</p>
	<p>1969110001100</p>	<p>REPOSIÇÃO MECANISMO DE SAIDA 3/6 LITROS</p> <p>SEM COR</p>

	<p>1969110006100</p>	<p>REPOSIÇÃO MECANISMO SAIDA D'AGUA 6 LITROS</p> <p>SEM COR</p>
	<p>1969110004100</p>	<p>REPOSIÇÃO VEDAÇÃO PARA CAIXA DESCARGA PLANO E FIXAÇÃO</p> <p>SEM COR</p>
	<p>BL00038BRR</p>	<p>TUBO RETO PARA BACIA SAIDA HORIZONTAL/DUAL</p> <p>BRANCO</p>
	<p>1969110011100</p>	<p>REFIL PASTILHA CLEANING DEVICE</p> <p>AZUL</p>



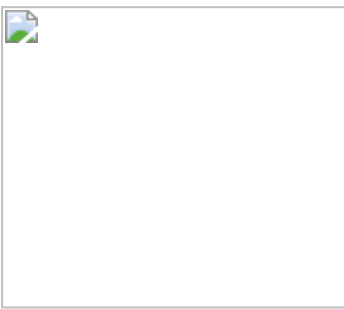

REPAROS LOUÇA

IMAGEM	CÓDIGO	DESCRIÇÃO
	AV0007500R	CJ FIXACAO P/ LAVATORIO SUSPENSO SEM COR

COMPLEMENTOS INCEPA

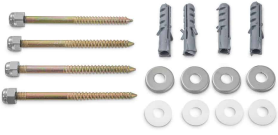
IMAGEM	CÓDIGO	DESCRIÇÃO
		FLEXIVEL DE ALIMENTAÇÃO 400 MM DE AÇO INOX TRANÇADO COM CANOPLA
	B5008R0CR3	CROMADO Caixa master: 6
		FLEXIVEL 300 MM AÇO INOX TRANÇADO COM CANOPLA
	B5007R0CR3	CROMADO Caixa master: 48

COMPLEMENTOS DE LOUÇ

IMAGEM	CÓDIGO	DESCRIÇÃO
	3006380000100	KIT INSTALACAO PARA BACIA CONVENCIONAL SEM COR
	3009750005500	CONJUNTO DE FIXAÇÃO PARA TANQUE P/M/G SEM COR
	3009750010100	CONJUNTO FIXACAO TIPO SUPORTE EM L SEM COR
	3009759000100	FIXAÇÃO (BACIA/ BIDE/ LAV) S-10 CR SEM COR
	3009750006100	FIXAÇÃO PARA LAVATÓRIOS SEM COR
	3009759010100	FIXACAO PARA MICTORIO PEQUENO S-10 SEM COR

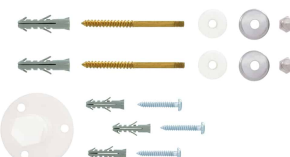
	3009759030100	FIXACAO PARA TANQUE GG/G BUILDERS S-12 SEM COR
	3009630910100	FIXACAO PARA LAVATORIO AZALEA CROMADO

		Peças em louça								
Produtos	Cores	1 Branco	2 Preto	48 Cinza Platina	51 Verde Água	57 Biscuit	7 Gris	10 Noir	14 Branco Matte	66 Cham pagne
	Platinum		•					•	•	•
Ocean		•								
Loft ¹		•	•			•	•	•	•	•
Serie Sensazioni		•								
Serie Due		•				•				
Neo		•					•	•	•	•
Boss		•					•	•	•	•
Suite		•								
Thema		•	•	•	•	•				
Avant		•								
First		•								
Art		•								
Flamigo		•	•	•		•				
Zip		•		•		•				

Peças em louça

Acesso	•								
Cubas de Sobrepor ²	•	•	•	•	•				
Cubas de Embutir ²	•	•	•	•	•				
Lavatórios	•								
Tanques	•				•				
Pro	•				•				
Kids	•								
Acessórios em Louça	•								

Preços

Para consultar o preço do produto, acesse <https://portalsistema.br.roca.net/>.

**Caso não tenha acesso converse com seu representante.*

Proposta de Compra

As propostas de compra estão sujeitas à nossa confirmação e o seu embarque à conformidade de sua produção.

Processada em: 01/03/2021 07:58:22

Modificações ou descontinuação de produtos

A Roca Brasil reserva o direito de modificar e/ou retirar de linha seus produtos e cores sem prévio aviso.

Medidas e cores

As medidas e cores de louças sanitárias estão sujeitas à pequenas variações, de acordo com a tolerância da indústria cerâmica e normas ABNT.

Notas importantes

Os assentos que compõem as fotos nas bacias podem ser de caráter ilustrativo e podem não estar inclusos no valor total dos produtos.

Importante verificar a validade desta tabela.

Múltiplos de pallet e caixa Master

Os múltiplos de pallet e caixa master são compostos por uma única cor.

Combo de Bacias e assentos

Os códigos de combos de bacias + assentos são somente para digitação. Na nota fiscal é registrado somente o código individual do produto.

Imagens são meramente ilustrativas.

Roca Sanitários Brasil Ltda.

Av. 14 de Dezembro, 2.800 - V. Mafalda - Jundiaí
CEP 13206-105 - SP - Brasil
Adm. Vendas - Tel 11 3230-0222

Export/Exportación Tel.: 55 113378-4660

Showroom
Av. Brasil, 2.188 - Jd. América
CEP 01430-001 - SP - Brasil
Tel. 11 3061-5266

Pós Vendas - 0800 70 11 300
www.incepa.com.br